

DIAMOND ANTENNA

CP-725H

40m, 15m, 10m and 6m (7/21/28-29 and 50MHz) Four-Band Vertical Antenna

Description

1. The CP-725H is a HF four-band vertical antenna.
2. Compact, light weight and very easy to assemble.
3. It is completely self-supported and does not need any guy wires.
4. Trap radials could be concentrated on one direction instead of spreading them around the antenna. This is especially convenient if the antenna is installed on a balcony railing.
5. Since the antenna is direct DC ground at the feed point, coaxial cable and transceiver are protected from the high voltage caused by lightning.
6. Center frequencies of the antenna are adjustable in each band by changing the length of each radial element.
7. Top loading structure utilizing capacitive hat enables the antenna to complete with full quarter wave length antennas in its performance.
8. It is rigid and rugged enough to withstand wind pressure over 100MPH.
9. Mast brackets area adjustable to accept 1 1/5" to 2 1/3" diameter mast.
10. Feed point section is kept waterproof by covering it with support pipe.
11. 10m FM band compatible.

Specifications

Freq. Range: 40, 15, 10, 6m
(7, 21, 28-29, 50MHz)

Impedance: 50Ω

VSWR: Less than 1.5

Max Power: 200W SSB (7MHz)

400W SSB (21MHz)

500W SSB (28/29/50MHz)

Max RF power rating of continuous wave (FM/CW) is about 1/3 of it in SSB mode.

Max Wind: 100 MPH

Height: 142"

Radial Element Length: 71"

Weight: 6.6 lbs.

Mast Diameter: 1 1/5" - 2 1/3"

Design: 4 band trap vertical antenna with trap radials

Though these products purchased are manufactured under strict quality control, if damage is caused by transporting, contact your dealer promptly.

Design and specifications of these products will be changed for future improvement without advance notice.

Installation Instructions

1. Don't install on a rainy or windy day.
2. Don't attempt to install the antenna by yourself. Installing the antenna alone on the roof may lead to a dangerous accident. Always ask a friend or family member for help.
3. Don't drop the antenna, tools and attachment when installing the antenna in it's height. Assemble the antenna on the ground before installing it.

Before Transmitting

1. Transmit after confirming if the antenna works normally by an SWR meter. If VSWR is higher than 1.5, stop transmitting and check that the antenna parts and coaxial cable are connected properly. If there are tall buildings, obstacles or the distance between the antenna and the ground is short, VSWR may not be lowered.
2. Diamond Antenna SWR/Power Meter is an insertion type being connected between a transmitter and an antenna. Transmitting power and SWR can be measured with very simple operations. In addition with those conventional measurements, PEP on SSB mode can be measured with a PEP monitor function. With our Diamond's wideband and low insertion loss directional coupler those measurements can be performed with minimum effect in transmission line.

During Transmitting

1. Do not touch the antenna during transmission as electrocution could occur. Take special care to keep children away from antenna during transmission.

Rumbling Thunder

If you hear thunder rumbling in the vicinity, don't touch the antenna or coaxial cable. Disconnect the cable from the radio when the radio is not in use.

If There is Something Wrong, Stop Transmitting Immediately

Continuing transmitting with high VSWR may cause damage to the radio. Stop transmitting immediately and check the following matters. If the antenna still doesn't seem to receive or propagate well, please contact the Diamond Antenna Corporation or your Diamond Antenna Dealer.

Check 1: Is the antenna too close to the building wall? If the obstacles are too close to the antenna, VSWR is higher and the radiation pattern is disturbed. Please install the antenna as far from the building as possible.

Check 2: Did you assemble the antenna correctly? Please read the instructions again and confirm the assembly.

Check 3: Check the coaxial cable to make sure the connector is properly installed and that the wire breaks by the volt-ohm meter.

Antenna Location

Resonate frequency of HF antenna can change based on location. Antenna should be mounted away from trees, buildings or other antennas.

1. If the CP-725H is located on the roof of a house or top of a building, look around the roof to see if there are any obstacles such as an electronic wire or TV antenna. The CP-725H has to be located as far away as possible from those things to obtain its maximum performance. Installing the antenna too close to the building wall may cause interference.

2. Don't install the antenna where it is easily reached by people.
3. Install the antenna firmly so it won't fall down. If by chance the antenna does fall, make sure it is installed where it won't come into contact with people, buildings, or power lines.
4. If the CP-725H is installed on a balcony railing, installing the antenna too close to the building wall may cause interference. Locate at least 7' - 16' away from the building wall.

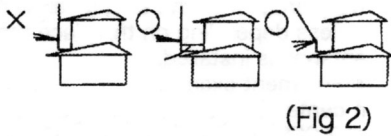

(Fig 2)

Note

1. Fastening the radial element trap coil assembly too tightly may cause damage.
2. In the case of spread around style radial elements, the turn to fix the radials is restricted. However, the radials of the lower frequencies are more influenced by the surrounding condition. Set the radials for 40m as far away as possible from the buildings.
3. In the case of the one direction style radial elements, set the radial for 40m and one and the radial for 15m at both ends (see Fig. 3 and 4).

One direction style radial elements



(Fig-3)

Spread around style radial elements



(Fig-4)

Assembly Instructions

1. Put radial element in each radial element trap coil assembly by referring to the typical element length listed in Table A and fasten it with element fastener ring. (Fig. 5).
2. Set grip nut rightly to threaded part of each radial element trap coil assembly.

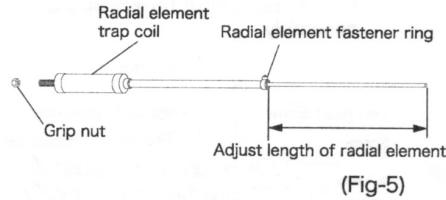

(Fig-5)

3. Connect pipe No. 1, double element trap coil assembly, and pipe No. 2 in the vertical element section. Fasten them with tapping screws and inner tooth washers by aligning holes in each joint section.
4. Attach four capacity hat assemblies to each capacity hat holder section. Capacity hat holders are set at the specified sections in the factory. Locations for those capacity hat holders are fixed at about 3.1" below the top end of double element trap coil assembly for lower capacity hat respectively.
5. Attach mast support pipe to mast with mast brackets. Mast support pipe's tapping hole has to be placed above the brackets and it has to be pointed outside against the mast. Upper end of mast support pipe has to be placed more than 4.7" above the top end of the mast.

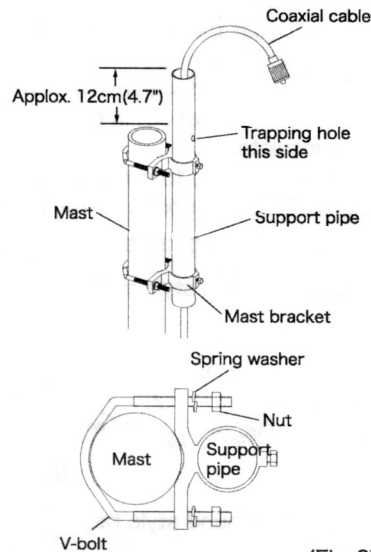

(Fig-6)

6. Place the radial element holder from upper end of the support pipe and fasten temporarily with screwdriver. Do not fasten too tightly at this stage, otherwise feedpoint assemblies might not be put into the support mast later.
7. Connect a coaxial cable to feedpoint assembly through the support pipe. Then align the hole in the lower part of feedpoint assembly with the hole in the support pipe and secure them with hex head screw and spring washer.

8. Place vertical element on feedpoint assembly and fix with two hex head screws and spring washers.
9. Turn each radial element into radial element holders. Then align water drain hole in each radial element trap coil assembly downward by turning backward and fasten each element with grip nut. Note that 6m radial element does not have trap coil assembly.

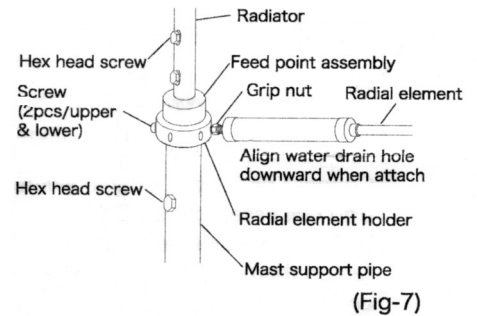

(Fig-7)

Note: To avoid breaking each radial element trap coil assembly, turn it into a holder lightly till it stops and turn backward to align water drain hole downward and secure with a screw.

Adjustment

Note for frequency adjustment: Practice the following adjustment procedure at the place where the antenna is actually installed. Test transmission for the adjustment has to be performed for as short time as possible and with as low RF power as possible. Maximum RF power rating of continuous wave (FM/CW) is about 1/3 of it in SSB mode. If the antenna is installed on a long balcony railing, the railing itself may work as a radial element and VSWR of the antenna may not be changed with the adjustment of attached radial element length. If resonant frequency of the antenna is within a desired range, the antenna can be used normally in this case. If resonant frequency is out of desired frequency range and adjustment is required, the antenna has to be isolated from the railing, moved to a different place or installed on a mast, which is at least 3.3' to 6.6' long.

1. Prepare suitable VSWR meter for operating frequencies and output RF power. Then connect it as shown below.

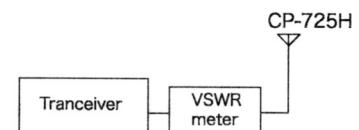

2. Adjustment procedure can be started from any frequency you like. Transmit at desired frequency and trim adjustment length of radial element to have lower VSWR at the frequency.

Adjustment Length of Radial Element

Adjustment length of each radial element is shown in the following table. If you do not have a VSWR meter, adjust it to a typical adjustment length.

| Band | Spread radials | One direction radials | Length/Frequency |
|----------------|----------------|-----------------------|------------------|
| 40m (7MHz) | Applox. 570mm | Applox. 530mm | 10mm/10KHz |
| 15m (21MHz) | Applox. 680mm | Applox. 620mm | 32mm/50KHz |
| 10m (28-29MHz) | Applox. 600mm | Applox. 590mm | 27mm/50KHz |
| 6m (50MHz) | Applox. 550mm | Applox. 550mm | 50mm/1MHz |

(Table A)

If the radial element of a band is made longer, resonant frequency of the band is made lower proportionally.

Though typical adjustment length of each radial element is set at center frequency of each band, it varies more or less depending on the place the antenna is installed.

Adjustment Example:

If center frequency of 40m band is set at 7.050MHz and real center frequency when the antenna is installed is at 7.010MHz, then frequency difference between is:

$$7.050\text{MHz (desired center frequency)} - 7.010\text{MHz (real center frequency)} = 40\text{KHz}$$

From Table A, adjustment length at 40m band is about 10mm per 10KHz, therefore: $10\text{mm} \times 40\text{KHz} / 10\text{KHz} = 40\text{mm}$. Since real center frequency is lower than desired center frequency, radial element has to be made 40mm shorter to have 7.050MHz center frequency.

·VSWR

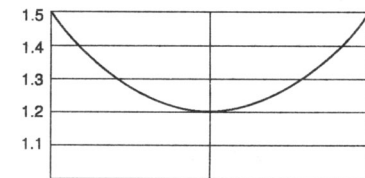

| | | | |
|-------|-------|----|-------|
| 7 | -14 | fo | +14 |
| 21 | -100 | fo | +100 |
| 28-29 | -125 | fo | +125 |
| 50 | -1500 | fo | +1500 |
| MHz | KHz | | KHz |

Parts Description

| Part # | Description | Qty | Part # | Description | Qty |
|--------|--|-----|--------|---|-----|
| M27001 | Mast bracket set | 2 | M27011 | 15m (21MHz) radial element trap coil assembly | 1 |
| M27002 | Mast support pipe | 1 | M27012 | 40m (7MHz) radial element trap coil assembly | 1 |
| M27003 | Radial element holder | 1 | M27013 | Radial element | 4 |
| M27004 | Feed point assembly | 1 | M27014 | Radial element fastener ring | 4 |
| M27005 | Pipe No. 1 ϕ 15 | 1 | M27015 | Grip nut | 4 |
| M27006 | Double element trap coil assembly | 1 | M27016 | Hex head screw M6 x 8 | 3 |
| M27007 | Pipe No. 2 ϕ 30 | 1 | M27017 | Spring Washer M6 | 3 |
| M27008 | Capacity hat assembly | 4 | M27018 | Tapping screw M4 x 8 | 4 |
| M27009 | 6m (50MHz) radial element trap coil assembly | 1 | M27019 | Internal tooth lock washer M4 | 4 |
| M27010 | 10m (28-29MHz) radial element trap coil assembly | 1 | M27020 | Capacity hat fastener ring | 1 |
| | | | M27021 | V-Bolt with nut | 2 |

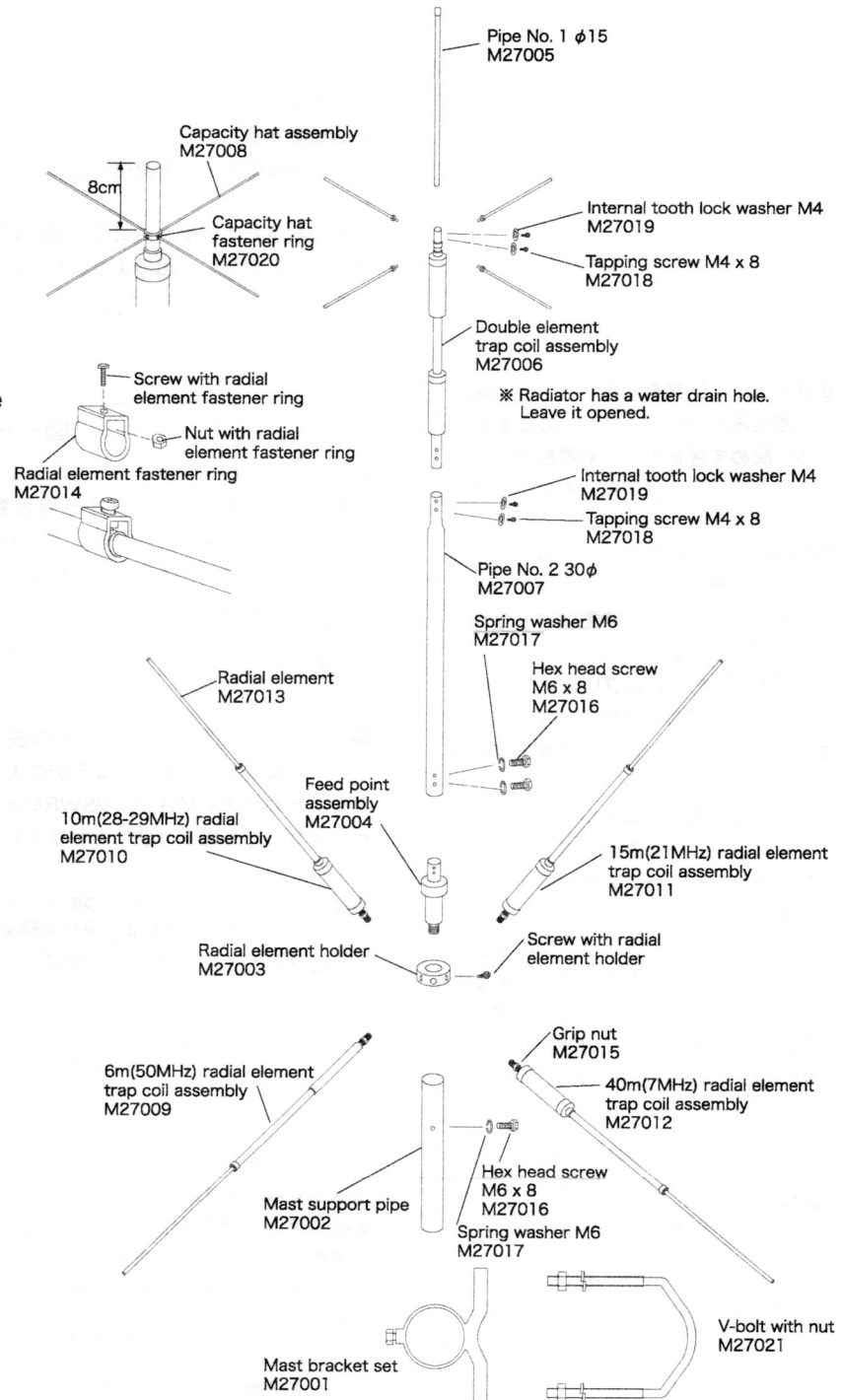



FOR YOUR SAFETY

Please read the following safety precautions before antenna assembly.

- Assemble the antenna on the ground or wide and flat place such as on balcony before installation.

- Do not assemble or install the antenna on a place where you can not have enough distance from any electric power lines.

- Do not install the antenna on a rainy or windy day.

- Do not attempt to install the antenna only by yourself. Installing the antenna alone on the roof may lead you to a dangerous accident. Always ask your friends or a professional for help installing the antenna.

- Do not use iron or aluminum ladder at a reachable distance from any electric power lines.

- Do not install the antenna on a mast which is not grounded properly.

- Do not have your family members or friends touch or come close to the antenna, unless they have realized its potential danger.

TO AVOID FATAL ACCIDENT

- Do not attempt to sustain the antenna, or any part of support structure if it begins to fall down. Let it fall by itself.
- Do not attempt to remove or restore the antenna or any part of support structure if it touches an electric power line. Let it be as it is, do not touch it, and call your local electric power company immediately.

IN CASE OF AN ACCIDENT

- Do not touch a person or an animal who is or seems to be in contact with the antenna or any support structure which is fallen on a live electric power line. Touching one may lead you to be electrocuted.
- Do not attempt to separate a person or an animal who is or seems to be in contact with the antenna or any support structure which is fallen on a live electric power line by yourself. Call or have someone call a police officer, ambulance, or doctor immediately.

ANTENNA INSTALLATION PRECAUTIONS

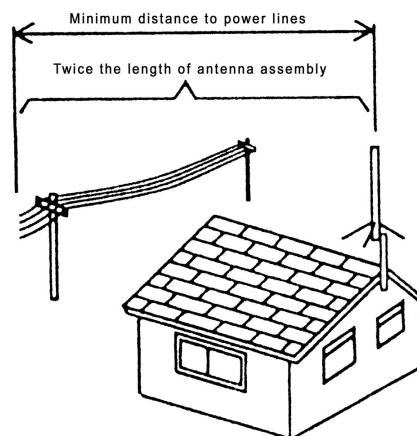

To determine antenna installation location, there are several factors to be taken into account. First thing is antenna propagation direction to specific target stations. As to whether there are any obstacles such as tall buildings on the line of sight. Next is specific installation location. As to whether specific location is adequate in terms of antenna support and surrounding safety.

- Do not attempt to install the antenna by yourself if you do not have any experience in installing base station antenna. Ask your experienced friends or a professional for help.
- Do not attempt to install the antenna at a location where it does not have enough distance from nearby electric power lines. It is advised to install the antenna at least twice of total antenna height from nearby electric power lines.
- Do not install the antenna on any type of tower, pole or telescopic mast which exceeds 30 feet high, if you do not have enough experience in installing the antenna on that kind of location. Ask your experienced friends or a professional for help.
- Do not use more than 1/10' section if you install the antenna on iron plumber's pipe. Attach guy wire if multiple pipes are used to install the antenna.