

ETSI EN 301 893 V1.3.1 (2005-08)

Candidate Harmonized European Standard (Telecommunications series)

**Broadband Radio Access Networks (BRAN);
5 GHz high performance RLAN;
Harmonized EN covering essential requirements
of article 3.2 of the R&TTE Directive**



Reference

REN/BRAN-0020002-2R1

Keywords

access, broadband, HIPERLAN, LAN, layer 1,
radio, testing

ETSI

650 Route des Lucioles
F-06921 Sophia Antipolis Cedex - FRANCE

Tel.: +33 4 92 94 42 00 Fax: +33 4 93 65 47 16

Siret N° 348 623 562 00017 - NAF 742 C
Association à but non lucratif enregistrée à la
Sous-Préfecture de Grasse (06) N° 7803/88

Important notice

Individual copies of the present document can be downloaded from:

<http://www.etsi.org>

The present document may be made available in more than one electronic version or in print. In any case of existing or perceived difference in contents between such versions, the reference version is the Portable Document Format (PDF). In case of dispute, the reference shall be the printing on ETSI printers of the PDF version kept on a specific network drive within ETSI Secretariat.

Users of the present document should be aware that the document may be subject to revision or change of status. Information on the current status of this and other ETSI documents is available at

<http://portal.etsi.org/tb/status/status.asp>

If you find errors in the present document, please send your comment to one of the following services:

http://portal.etsi.org/chaicor/ETSI_support.asp

Copyright Notification

No part may be reproduced except as authorized by written permission.
The copyright and the foregoing restriction extend to reproduction in all media.

© European Telecommunications Standards Institute 2005.
All rights reserved.

DECT™, **PLUGTESTS™** and **UMTS™** are Trade Marks of ETSI registered for the benefit of its Members.
TIPHON™ and the **TIPHON logo** are Trade Marks currently being registered by ETSI for the benefit of its Members.
3GPP™ is a Trade Mark of ETSI registered for the benefit of its Members and of the 3GPP Organizational Partners.

Contents

Intellectual Property Rights	6
Foreword.....	6
Introduction	7
1 Scope	9
2 References	10
3 Definitions, symbols and abbreviations	10
3.1 Definitions	10
3.2 Symbols.....	12
3.3 Abbreviations	12
4 Technical requirements specifications	12
4.1 Environmental profile.....	12
4.2 Carrier frequencies	13
4.2.1 Definition.....	13
4.2.2 Limits.....	13
4.2.3 Conformance.....	13
4.3 RF output power, Transmit Power Control (TPC) and power density	13
4.3.1 Definitions	13
4.3.1.1 RF output power.....	13
4.3.1.2 Transmit Power Control (TPC).....	13
4.3.1.3 Power density.....	13
4.3.2 Limits.....	13
4.3.2.1 RF output power and power density at the highest power level.....	13
4.3.2.2 RF output power at the lowest power level of the TPC range.....	14
4.3.3 Conformance.....	14
4.4 Transmitter unwanted emissions	14
4.4.1 Transmitter unwanted emissions outside the 5 GHz RLAN bands	14
4.4.1.1 Definition	14
4.4.1.2 Limits	14
4.4.1.3 Conformance.....	14
4.4.2 Transmitter unwanted emissions within the 5 GHz RLAN bands	14
4.4.2.1 Definition	14
4.4.2.2 Limits	15
4.4.2.3 Conformance.....	15
4.5 Receiver spurious emissions.....	15
4.5.1 Definition.....	15
4.5.2 Limits.....	15
4.5.3 Conformance.....	15
4.6 Dynamic Frequency Selection (DFS).....	16
4.6.1 Introduction.....	16
4.6.1.1 Operational modes	16
4.6.1.2 DFS operation	16
4.6.2 DFS technical requirements specifications	17
4.6.2.1 Channel Availability Check	17
4.6.2.1.1 Definition.....	17
4.6.2.1.2 Limit	17
4.6.2.1.3 Conformance	17
4.6.2.2 In-Service Monitoring.....	18
4.6.2.2.1 Definition.....	18
4.6.2.2.2 Limit.....	18
4.6.2.2.3 Conformance	18
4.6.2.3 Channel Shutdown	18
4.6.2.3.1 Definition.....	18
4.6.2.3.2 Limit.....	18

4.6.2.3.3	Conformance	18
4.6.2.4	Non-Occupancy Period	18
4.6.2.4.1	Definition.....	18
4.6.2.4.2	Limit.....	19
4.6.2.4.3	Conformance	19
4.6.2.5	Uniform Spreading.....	19
4.6.2.5.1	Definition.....	19
4.6.2.5.2	Limit.....	19
5	Testing for compliance with technical requirements.....	19
5.1	Conditions for testing	19
5.1.1	Normal and extreme test conditions.....	19
5.1.2	Test sequences and traffic load	19
5.1.2.1	General test transmission sequences	19
5.1.2.2	Test transmission sequences for DFS tests.....	20
5.1.3	Test frequencies	20
5.1.4	Presentation of equipment	20
5.1.4.1	Integrated and dedicated antennas.....	20
5.1.4.2	Testing of host connected equipment and plug-in radio devices.....	20
5.1.4.2.1	The use of a host or test jig for testing plug-in radio devices	20
5.1.4.2.2	Testing of combinations	21
5.2	Interpretation of the measurement results	22
5.3	Essential radio test suites.....	22
5.3.1	Product information	22
5.3.2	Carrier frequencies.....	23
5.3.2.1	Test conditions	23
5.3.2.2	Test methods	23
5.3.2.2.1	Conducted measurement.....	23
5.3.2.2.2	Radiated measurement.....	24
5.3.3	RF output power, Transmit Power Control (TPC) and power density.....	24
5.3.3.1	Test conditions	24
5.3.3.2	Test method.....	24
5.3.3.2.1	Conducted measurement.....	24
5.3.3.2.2	Radiated measurement.....	27
5.3.4	Transmitter unwanted emissions outside the 5 GHz RLAN bands.....	27
5.3.4.1	Test conditions	27
5.3.4.2	Test method.....	27
5.3.4.2.1	Conducted measurement.....	27
5.3.4.2.2	Radiated measurement.....	28
5.3.5	Transmitter unwanted emissions within the 5 GHz RLAN bands	29
5.3.5.1	Test conditions	29
5.3.5.2	Test method.....	29
5.3.5.2.1	Conducted measurement.....	29
5.3.5.2.2	Radiated measurement.....	30
5.3.6	Receiver spurious emissions	30
5.3.6.1	Test conditions	30
5.3.6.2	Test method.....	30
5.3.6.2.1	Conducted measurement.....	30
5.3.6.2.2	Radiated measurement.....	30
5.3.7	Dynamic Frequency Selection (DFS)	31
5.3.7.1	Test conditions	31
5.3.7.1.1	Selection of radar test signals	31
5.3.7.1.2	Test set-ups.....	31
5.3.7.2	Test Method	32
5.3.7.2.1	Conducted measurement.....	32
5.3.7.2.2	Radiated measurement.....	37
Annex A (normative):	The EN Requirements Table (EN-RT)	38
Annex B (normative):	Test sites and arrangements for radiated measurements.....	39
B.1	Test sites.....	39
B.1.1	Open air test sites	39

B.1.2	Anechoic chamber	40
B.1.2.1	General.....	40
B.1.2.2	Description.....	40
B.1.2.3	Influence of parasitic reflections.....	40
B.1.2.4	Calibration and mode of use	41
B.2	Test antenna.....	42
B.3	Substitution antenna	43
Annex C (normative):	General description of measurement	44
C.1	Conducted measurements.....	44
C.2	Radiated measurements.....	44
C.3	Substitution measurement	45
Annex D (normative):	DFS parameters	46
Annex E (informative):	The EN title in the official languages	48
Annex F (informative):	Bibliography.....	49
History		50

Intellectual Property Rights

IPRs essential or potentially essential to the present document may have been declared to ETSI. The information pertaining to these essential IPRs, if any, is publicly available for **ETSI members and non-members**, and can be found in ETSI SR 000 314: "*Intellectual Property Rights (IPRs); Essential, or potentially Essential, IPRs notified to ETSI in respect of ETSI standards*", which is available from the ETSI Secretariat. Latest updates are available on the ETSI Web server (<http://webapp.etsi.org/IPR/home.asp>).

Pursuant to the ETSI IPR Policy, no investigation, including IPR searches, has been carried out by ETSI. No guarantee can be given as to the existence of other IPRs not referenced in ETSI SR 000 314 (or the updates on the ETSI Web server) which are, or may be, or may become, essential to the present document.

Foreword

This Candidate Harmonized European Standard (Telecommunications series) has been produced by ETSI Project Broadband Radio Access Networks (BRAN).

The present document has been produced by ETSI in response to a mandate from the European Commission issued under Council Directive 98/34/EC (as amended) laying down a procedure for the provision of information in the field of technical standards and regulations.

The present document is intended to become a Harmonized Standard, the reference of which will be published in the Official Journal of the European Communities referencing the Directive 1999/5/EC of the European Parliament and of the Council of 9 March 1999 on radio equipment and telecommunications terminal equipment and the mutual recognition of their conformity ("the R&TTE Directive") [1].

Technical specifications relevant to Directive 1999/5/EC are given in annex A.

National transposition dates	
Date of adoption of this EN:	29 July 2005
Date of latest announcement of this EN (doa):	31 October 2005
Date of latest publication of new National Standard or endorsement of this EN (dop/e):	30 April 2006
Date of withdrawal of any conflicting National Standard (dow):	30 April 2007

Introduction

The present document is part of a set of standards designed to fit in a modular structure to cover all radio and telecommunications terminal equipment under the R&TTE Directive [1]. Each standard is a module in the structure. The modular structure is shown in figure 1.

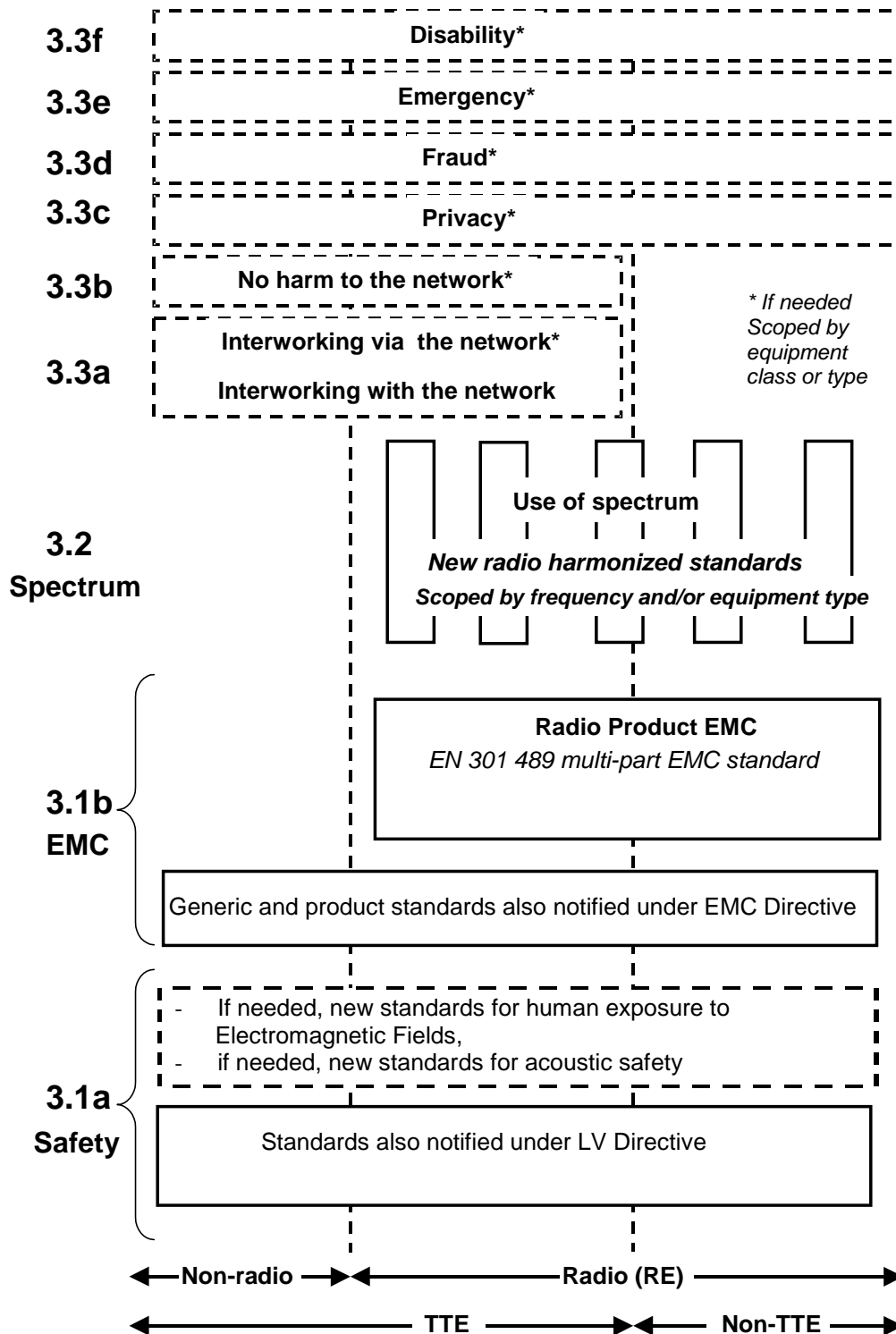

Figure 1: Modular structure for the various standards used under the R&TTE Directive [1]

The left hand edge of the figure 1 shows the different clauses of article 3 of the R&TTE Directive [1].

For article 3.3 various horizontal boxes are shown. Dotted lines indicate that at the time of publication of the present document essential requirements in these areas have to be adopted by the Commission. If such essential requirements are adopted, and as far and as long as they are applicable, they will justify individual standards whose scope is likely to be specified by function or interface type.

The vertical boxes show the standards under article 3.2 for the use of the radio spectrum by radio equipment. The scopes of these standards are specified either by frequency (normally in the case where frequency bands are harmonized) or by radio equipment type.

For article 3.1b the diagram shows EN 301 489 [8], the multi-part product EMC standard for radio used under the EMC Directive [2].

For article 3.1a the diagram shows the existing safety standards currently used under the LV Directive [3] and new standards covering human exposure to electromagnetic fields. New standards covering acoustic safety may also be required.

The bottom of the figure shows the relationship of the standards to radio equipment and telecommunications terminal equipment. A particular equipment may be radio equipment, telecommunications terminal equipment or both. A radio spectrum standard will apply if it is radio equipment. An article 3.3 standard will apply as well only if the relevant essential requirement under the R&TTE Directive [1] is adopted by the Commission and if the equipment in question is covered by the scope of the corresponding standard. Thus, depending on the nature of the equipment, the essential requirements under the R&TTE Directive [1] may be covered in a set of standards.

The modularity principle has been taken because:

- It minimizes the number of standards needed. Because equipment may, in fact, have multiple interfaces and functions it is not practicable to produce a single standard for each possible combination of functions that may occur in an equipment.
- It provides scope for standards to be added:
 - under article 3.2 when new frequency bands are agreed; or
 - under article 3.3 should the Commission take the necessary decisionswithout requiring alteration of standards that are already published.
- It clarifies, simplifies and promotes the usage of Harmonized Standards as the relevant means of conformity assessment.

1 Scope

The present document applies to 5 GHz high performance RLAN equipment that is intended to operate in the frequency ranges 5 150 MHz to 5 350 MHz and 5 470 MHz to 5 725 MHz on any of the carrier frequencies as per table 1. Specific requirements are described for (equipment having the capability of) avoiding occupied channels by employing a Dynamic Frequency Selection (DFS) mechanism and implementing Transmit Power Control (TPC), as required in ECC/DEC(04)08 [7].

NOTE 1: This mechanism is also required and described in ITU-R Recommendation M.1652 (see bibliography).

Table 1: Nominal carrier frequency allocations

Carrier centre frequency f_c
5 180 MHz
5 200 MHz
5 220 MHz
5 240 MHz
5 260 MHz
5 280 MHz
5 300 MHz
5 320 MHz
5 500 MHz
5 520 MHz
5 540 MHz
5 560 MHz
5 580 MHz
5 600 MHz
5 620 MHz
5 640 MHz
5 660 MHz
5 680 MHz
5 700 MHz

The present document is intended to cover the provisions of article 3.2 of R&TTE Directive [1], which states that: "...radio equipment shall be so constructed that it effectively uses the spectrum allocated to terrestrial/space radio communications and orbital resources so as to avoid harmful interference".

In addition to the present document, other ENs that specify technical requirements in respect of essential requirements under other parts of article 3 of the R&TTE Directive [1] will apply to equipment within the scope of the present document.

NOTE 2: A list of such ENs is included on the web site <http://www.newapproach.org>.

2 References

The following documents contain provisions which, through reference in this text, constitute provisions of the present document.

- References are either specific (identified by date of publication and/or edition number or version number) or non-specific.
- For a specific reference, subsequent revisions do not apply.
- For a non-specific reference, the latest version applies.

Referenced documents which are not found to be publicly available in the expected location might be found at <http://docbox.etsi.org/Reference>.

- [1] Directive 1999/5/EC of the European Parliament and of the Council of 9 March 1999 on radio equipment and telecommunications terminal equipment and the mutual recognition of their conformity (R&TTE Directive).
- [2] Council Directive 89/336/EEC of 3 May 1989 on the approximation of the laws of the Member States relating to electromagnetic compatibility (EMC Directive).
- [3] Council Directive 73/23/EEC of 19 February 1973 on the harmonization of the laws of Member States relating to electrical equipment designed for use within certain voltage limits (LV Directive).
- [4] ETSI TR 100 028-1: "Electromagnetic compatibility and Radio spectrum Matters (ERM); Uncertainties in the measurement of mobile radio equipment characteristics; Part 1".
- [5] ETSI TR 100 028-2: "Electromagnetic compatibility and Radio spectrum Matters (ERM); Uncertainties in the measurement of mobile radio equipment characteristics; Part 2".
- [6] CISPR 16-1: "Specification for radio disturbance and immunity measuring apparatus and methods - Part 1: Radio disturbance and immunity measuring apparatus".
- [7] ECC/DEC(04)08: "ECC Decision of 12 November 2004 on the harmonised use of the 5 GHz frequency bands for the implementation of Wireless Access Systems including Radio Local Area Networks (WAS/RLANs)".
- [8] ETSI EN 301 489: "Electromagnetic compatibility and Radio spectrum Matters (ERM); ElectroMagnetic Compatibility (EMC) standard for radio equipment and services".

3 Definitions, symbols and abbreviations

3.1 Definitions

For the purposes of the present document, the terms and definitions given in the R&TTE Directive [1] and the following apply:

5 GHz RLAN bands: total frequency range that consists of 2 sub-bands:

- 5 150 MHz to 5 350 MHz; and
- 5 470 MHz to 5 725 MHz.

ad-hoc mode: operating mode in which an RLAN device establishes a temporary wireless connection with other RLAN devices without a controlling network infrastructure

Available Channel: channel identified as available for use as an *Operating Channel* without having to perform a *Channel Availability Check* first

burst: period during which radio waves are intentionally transmitted, preceded and succeeded by periods during which no intentional transmission is made

channel: amount of spectrum used by a single RLAN device operating on one of the carrier frequencies listed in table 1 of EN 301 893

combined equipment: any combination of non-radio equipment that requires a plug-in radio device to offer full functionality

environmental profile: range of environmental conditions under which equipment within the scope of EN 301 893 is required to comply with the provisions of EN 301 893

host equipment: any equipment which has complete user functionality when not connected to the radio equipment part and to which the radio equipment part provides additional functionality and to which connection is necessary for the radio equipment part to offer functionality

master mode: mode which relates to the DFS functionality where the RLAN device uses a Radar Interference Detection function and controls the transmissions of RLAN devices operating in slave mode

NOTE: In this mode it is able to select a channel and initiate a network by sending enabling signals to other RLAN devices. An RLAN network shall always have at least one RLAN device operating in master mode when operating in the bands 5 250 MHz to 5 350 MHz and 5 470 MHz to 5 725 MHz.

multi-radio equipment: radio, host or combined equipment using more than one radio transceiver

Operating Channel: *Available Channel* on which the RLAN has started transmissions. An *Operating Channel* becomes again an *Available Channel* if the RLAN stopped all transmissions on that channel and no radar signal was detected by the *In-Service Monitoring*

plug-in radio device: radio equipment module intended to be used with or within host, combined or multi-radio equipment, using their control functions and power supply

simulated radar burst: series of periodic radio wave pulses for test purposes

slave mode: mode which relates to the DFS functionality where the transmissions of the RLAN are under control of a RLAN device operating in master mode

NOTE: An RLAN device in slave mode may use a Radar Interference Detection function.

stand-alone radio equipment: equipment that is intended primarily as communications equipment and that is normally used on a stand-alone basis

Transmit Power Control (TPC): technique in which the transmitter output power is controlled resulting in reduced interference to other systems

Unavailable Channel: channel which can not be considered by the RLAN for a certain period of time (*Non-Occupancy Period*) after a radar signal was detected on that channel

Usable Channel: any channel from table 1 of EN 301 893, which can be considered by the RLAN for possible use, unless it is precluded by either:

- 1) the intended outdoor usage of the RLAN; or
- 2) previous detection of a radar on the channel (*Unavailable Channel*); or
- 3) national regulations; or
- 4) the restriction to only operate in the band 5 150 MHz to 5 250 MHz for RLAN devices without a radar detection capability.

3.2 Symbols

For the purposes of the present document, the following symbols apply:

A	Measured power output (dBm)
B	Radar burst period
Ch _f	Channel free from radars
Ch _r	Channel occupied by a radar
D	Measured power density
E	Field strength
E _o	Reference field strength
f _c	Carrier frequency
G	Antenna gain (dBi)
L	Radar burst length
n	Number of channels
P _H	Calculated EIRP at highest power level
P _L	Calculated EIRP at lowest power level
PD	Calculated power density
R	Distance
R _o	Reference distance
S ₀	Signal power
T ₀	Time instant
T ₁	Time instant
T ₂	Time instant
T ₃	Time instant
W	Radar pulse width
x	Observed duty cycle

3.3 Abbreviations

For the purposes of the present document, the following abbreviations apply:

DFS	Dynamic Frequency Selection
EIRP	Equivalent Isotropically Radiated Power
EMC	ElectroMagnetic Compatibility
ERP	Effective Radiated Power
LV	Low Voltage
ppm	parts per million
PRF	Pulse Repetition Frequency
R&TTE	Radio and Telecommunications Terminal Equipment
TPC	Transmit Power Control
Tx	Transmit, Transmitter
UUT	Unit Under Test

4 Technical requirements specifications

4.1 Environmental profile

The technical requirements of the present document apply under the environmental profile for operation of the equipment, which shall be stated by the manufacturer. The equipment shall comply with all the technical requirements of the present document at all times when operating within the boundary limits of the stated operational environmental profile.

4.2 Carrier frequencies

4.2.1 Definition

The equipment is required to operate on the applicable specific carrier centre frequencies that correspond to the nominal carrier frequencies f_c defined in table 1.

4.2.2 Limits

The actual carrier centre frequency for any given channel given in table 1 shall be maintained within the range $f_c \pm 20$ ppm.

4.2.3 Conformance

Conformance tests as defined in clause 5.3.2 shall be carried out.

4.3 RF output power, Transmit Power Control (TPC) and power density

4.3.1 Definitions

4.3.1.1 RF output power

The RF output power is the mean equivalent isotropically radiated power (EIRP) during a transmission burst.

4.3.1.2 Transmit Power Control (TPC)

Transmit Power Control (TPC) is a mechanism to be used by the UUT to ensure a mitigation factor of at least 3 dB on the aggregate power from a large number of devices. This requires the UUT to have a TPC range from which the lowest value is at least 6 dB below the values for mean EIRP given in table 2. TPC is not required in the band 5 150 MHz to 5 250 MHz.

4.3.1.3 Power density

The power density is the mean Equivalent Isotropically Radiated Power (EIRP) density during a transmission burst.

4.3.2 Limits

4.3.2.1 RF output power and power density at the highest power level

For devices with TPC, the RF output power and the power density when configured to operate at the highest stated power level of the TPC range shall not exceed the levels given in table 2.

For devices without TPC, the limits in table 2 shall be reduced by 3 dB, except when operating in the band 5 150 MHz to 5 250 MHz.

Table 2: Mean EIRP limits for RF output power and power density at the highest power level

Frequency range	Mean EIRP limit	Mean EIRP density limit
5 150 MHz to 5 350 MHz	23 dBm	10 dBm/MHz
5 470 MHz to 5 725 MHz	30 dBm	17 dBm/MHz

4.3.2.2 RF output power at the lowest power level of the TPC range

For devices using TPC, the RF output power during a transmission burst when configured to operate at the lowest stated power level of the TPC range shall not exceed the levels given in table 3.

Table 3: Mean EIRP limits for RF output power at the lowest power level of the TPC range

Frequency range	Mean EIRP
5 250 MHz to 5 350 MHz	17 dBm
5 470 MHz to 5 725 MHz	24 dBm

The limits in table 3 do not apply for devices without TPC or when operating in the band 5 150 MHz to 5 250 MHz.

4.3.3 Conformance

Conformance tests as defined in clause 5.3.3 shall be carried out.

4.4 Transmitter unwanted emissions

4.4.1 Transmitter unwanted emissions outside the 5 GHz RLAN bands

4.4.1.1 Definition

These are radio frequency emissions outside the 5 GHz RLAN bands.

4.4.1.2 Limits

The level of unwanted emission shall not exceed the limits given in table 4.

Table 4: Transmitter unwanted emission limits outside the 5 GHz RLAN bands

Frequency range	Maximum power, ERP	Bandwidth
30 MHz to 47 MHz	-36 dBm	100 kHz
47 MHz to 74 MHz	-54 dBm	100 kHz
74 MHz to 87,5 MHz	-36 dBm	100 kHz
87,5 MHz to 118 MHz	-54 dBm	100 kHz
118 MHz to 174 MHz	-36 dBm	100 kHz
174 MHz to 230 MHz	-54 dBm	100 kHz
230 MHz to 470 MHz	-36 dBm	100 kHz
470 MHz to 862 MHz	-54 dBm	100 kHz
862 MHz to 1 GHz	-36 dBm	100 kHz
1 GHz to 5,15 GHz	-30 dBm	1 MHz
5,35 GHz to 5,47 GHz	-30 dBm	1 MHz
5,725 GHz to 26,5 GHz	-30 dBm	1 MHz

4.4.1.3 Conformance

Conformance tests as defined in clause 5.3.4 shall be carried out.

4.4.2 Transmitter unwanted emissions within the 5 GHz RLAN bands

4.4.2.1 Definition

These are radio frequency emissions within the 5 GHz RLAN bands.

4.4.2.2 Limits

The average level of the transmitted spectrum within the 5 GHz RLAN bands shall not exceed the limits given in figure 2.

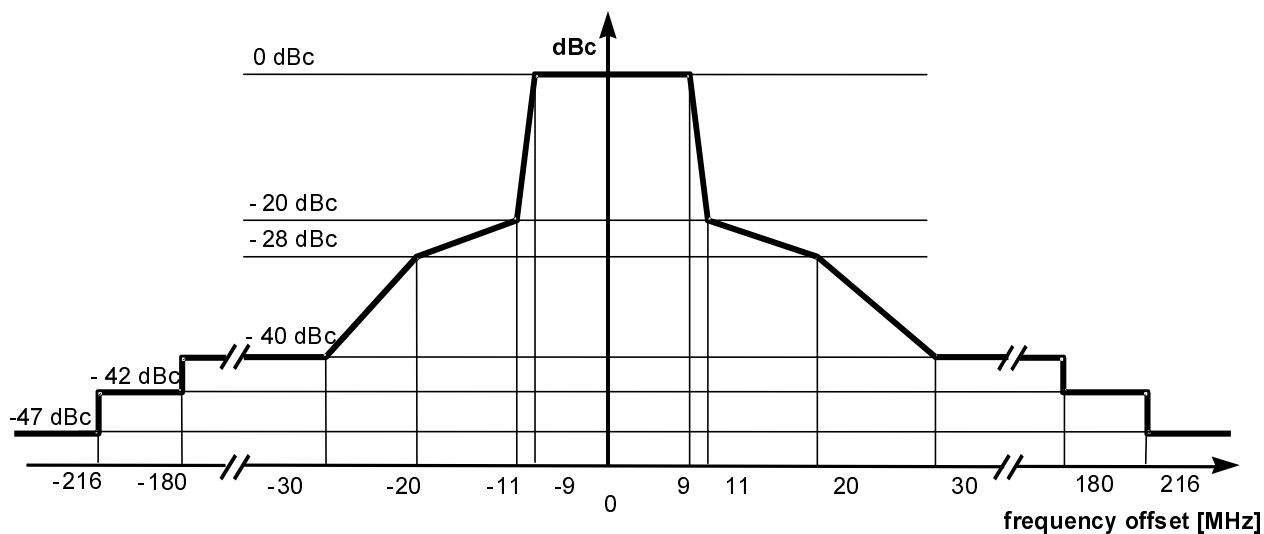

NOTE: dBc is the spectral density relative to the maximum spectral power density of the transmitted signal.

Figure 2: Transmit spectral power mask

4.4.2.3 Conformance

Conformance tests as defined in clause 5.3.5 shall be carried out.

4.5 Receiver spurious emissions

4.5.1 Definition

Receiver spurious emissions are emissions at any frequency when the equipment is in receive mode.

4.5.2 Limits

The spurious emissions of the receiver shall not exceed the limits given in table 5.

Table 5: Spurious radiated emission limits

Frequency range	Maximum power, ERP	Measurement bandwidth
30 MHz to 1 GHz	-57 dBm	100 kHz
1 GHz to 26,5 GHz	-47 dBm	1 MHz

4.5.3 Conformance

Conformance tests as defined in clause 5.3.6 shall be carried out.

4.6 Dynamic Frequency Selection (DFS)

4.6.1 Introduction

An RLAN shall employ a Dynamic Frequency Selection (DFS) function to:

- detect interference from other systems and to avoid co-channel operation with these systems, notably radar systems;
- provide on aggregate a uniform loading of the spectrum across all devices.

DFS is required in the frequency ranges 5 250 MHz to 5 350 MHz and 5 470 MHz to 5 725 MHz. This requirement applies to all types of RLAN devices and to any type of communication between these devices.

Radar detection is not required in the frequency range 5 150 MHz to 5 250 MHz.

The DFS function as described in the present document is not tested for its ability to detect frequency hopping radar signals.

4.6.1.1 Operational modes

Within the context of the operation of the DFS function, an RLAN device shall operate in either master mode or slave mode. RLAN devices operating in slave mode (slave device) shall only operate in a network controlled by a RLAN device operating in master mode (master device).

Some RLAN devices are capable of communicating in ad-hoc manner without being attached to a network. Devices operating in this manner in the range 5 250 MHz to 5 350 MHz and 5 470 MHz to 5 725 MHz shall employ DFS and should be tested against the requirements applicable to a master.

4.6.1.2 DFS operation

The operational behaviour and individual DFS requirements that are associated with master and slave devices are as follows:

Master devices:

- a) The master device shall use a Radar Interference Detection function in order to detect radar signals.
- b) Before initiating a network on a channel, which has not been identified as an *Available Channel*, the master device shall perform a *Channel Availability Check* to ensure that there is no radar operating on the channel.
- c) During normal operation, the master device shall monitor the *Operating Channel (In-Service Monitoring)* to ensure that there is no radar operating on the channel.
- d) If the master device has detected a radar signal during *In-Service Monitoring*, the *Operating Channel* is made unavailable. The master device shall instruct all its associated slave devices to stop transmitting on this (to become unavailable) channel.
- e) The master device shall not resume any transmissions on this *Unavailable Channel* during a period of time after a radar signal was detected. This period is referred as the *Non-Occupancy Period*.

Slave devices:

- a) A slave device shall not transmit before receiving an appropriate enabling signal from a master device.
- b) A slave device shall stop all its transmissions whenever instructed by a master device to which it is associated. The device shall not resume any transmissions until it has again received an appropriate enabling signal from a master device.
- c) A slave device which is required to perform radar detection (see table D.3), shall stop its own transmissions if it has detected a radar.

See table 6 in clause 4.6.2 for the applicability of DFS requirements for each of the above mentioned operational modes.

The master device may implement the Radar Interference Detection function referred to under a) using another device associated with the master. In such a case, the combination shall be tested against the requirements applicable to the master.

The maximum power level of a slave device will define whether or not the device needs to have a Radar Interference Detection function (see table D.3).

4.6.2 DFS technical requirements specifications

Table 6 lists the DFS related essential requirements and their applicability for each of the operational modes described in clause 4.6.1. If the RLAN device is capable of operating in more than one operating mode then each operating mode shall be assessed separately

Table 6: Applicability of DFS requirements

Requirement	Operating mode		
	Master	Slave (without radar detection)	Slave (with radar detection)
Channel Availability Check	✓	Not required	Not required
In-Service Monitoring	✓	Not required	✓
Channel Shutdown	✓	✓	✓
Non-Occupancy Period	✓	Not required	Not required
Uniform Spreading	✓	Not required	Not required

Table 7: Void

4.6.2.1 Channel Availability Check

4.6.2.1.1 Definition

The *Channel Availability Check* is defined as the mechanism by which an RLAN device checks a channel for the presence of radar signals.

There shall be no transmissions by the device within the channel being checked during this process.

If no radars have been detected, the channel becomes an *Available Channel* valid for a period of time.

The RLAN shall only start transmissions on *Available Channels*.

At power-up, the RLAN is assumed to have no *Available Channels*.

4.6.2.1.2 Limit

The *Channel Availability Check* shall be performed during a continuous period in time (*Channel Availability Check Time*) which shall not be less than the value defined in table D.1.

During the *Channel Availability Check*, the RLAN shall be capable of detecting any of the radar signals that fall within the range given by table D.4 with a level above the *Interference Detection Threshold* defined in tables D.2. and D.3.

The detection probability for a given radar signal shall be greater than the value defined in table D.4.

Available channels remain valid for a maximum period of 24 hours.

4.6.2.1.3 Conformance

Conformance tests for this requirement are defined in clause 5.3.7.

4.6.2.2 In-Service Monitoring

4.6.2.2.1 Definition

The *In-Service Monitoring* is defined as the process by which an RLAN monitors the *Operating Channel* for the presence of radar signals.

4.6.2.2.2 Limit

The *In-Service Monitoring* shall be used to continuously monitor an *Operating Channel*.

The *In-Service-Monitoring* shall start immediately after the RLAN has started transmissions on an *Operating Channel*.

During the *In-Service Monitoring*, the RLAN shall be capable of detecting any of the radar signals that fall within the range given by table D.4 with a level above the *Interference Detection Threshold* defined in tables D.2. and D.3.

The detection probability for a given radar signal shall be greater than the value defined in table D.4.

4.6.2.2.3 Conformance

Conformance tests for this requirement are defined in clause 5.3.7.

4.6.2.3 Channel Shutdown

4.6.2.3.1 Definition

The *Channel Shutdown* is defined as the process initiated by the RLAN device immediately after a radar signal has been detected on an *Operating Channel*.

The master device shall instruct all associated slave devices to stop transmitting on this channel, which they shall do within the *Channel Move Time*.

Slave devices with a Radar Interference Detection function, shall stop their own transmissions within the *Channel Move Time*.

The aggregate duration of all transmissions of the RLAN device on this channel during the *Channel Move Time* shall be limited to the *Channel Closing Transmission Time*. The aggregate duration of all transmissions shall not include quiet periods in between transmissions.

4.6.2.3.2 Limit

The *Channel Shutdown* process shall start immediately after a radar signal has been detected.

The *Channel Move Time* shall not exceed the limit defined in table D.1.

The *Channel Closing Transmission Time* shall not exceed the limit defined in table D.1.

4.6.2.3.3 Conformance

Conformance tests for this requirement are defined in clause 5.3.7.

4.6.2.4 Non-Occupancy Period

4.6.2.4.1 Definition

The *Non-Occupancy Period* is defined as the time during which the RLAN device shall not make any transmissions on a channel after a radar signal was detected on that channel by either the *Channel Availability Check* or the *In-Service Monitoring*.

NOTE: A new *Channel Availability Check* is required before the channel can be identified again as an *Available Channel*.

4.6.2.4.2 Limit

The *Non-Occupancy Period* shall not be less than the value defined in table D.1.

4.6.2.4.3 Conformance

Conformance tests for this requirement are defined in clause 5.3.7.

4.6.2.5 Uniform Spreading

4.6.2.5.1 Definition

The *Uniform Spreading* is a mechanism to be used by the RLAN to provide, on aggregate, a uniform loading of the spectrum across all devices.

This requires that a RLAN device shall select a channel out of the list of usable channels so that the probability of selecting a given channel shall be the same for all channels.

When implementing a frequency re-use plan across a planned network, the selection of the *Operating Channel* may be under control of the network .

4.6.2.5.2 Limit

The probability of selecting each of the usable channels shall be within 10 % of the theoretical probability. For "n" channels, the theoretical probability is $1/n$.

5 Testing for compliance with technical requirements

5.1 Conditions for testing

5.1.1 Normal and extreme test conditions

Tests defined in the present document shall be carried out under normal test conditions and where stated, under the extreme test conditions as declared by the manufacturer.

5.1.2 Test sequences and traffic load

5.1.2.1 General test transmission sequences

Except for the DFS tests or if mentioned otherwise, all the tests in the present document shall be performed by using a test transmission sequence that shall consist of regularly transmitted packets with an interval of e.g. 2 ms. The test transmissions shall be fixed in length in a sequence and shall exceed the transmitter minimum activity ratio of 10 %. The minimum duration of the sequence shall be adequate for the test purposes.

The general structure of the test transmission sequence is shown in figure 3.

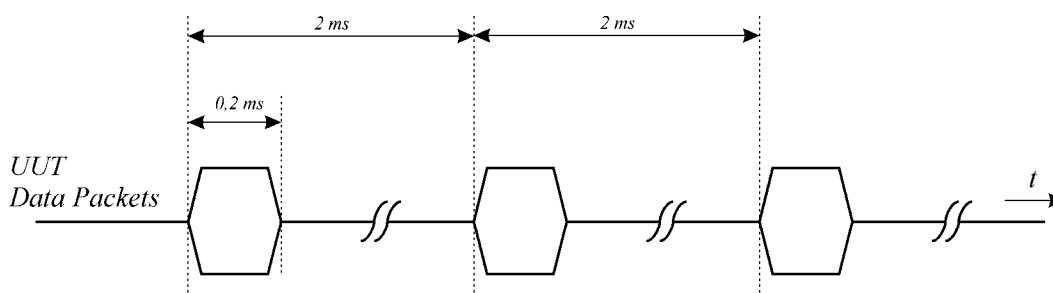

Figure 3: General structure of the test transmission sequences

5.1.2.2 Test transmission sequences for DFS tests

The DFS tests in the present document shall be performed by using a test transmission sequence that shall consist of packet transmissions that together exceed the transmitter minimum activity ratio of 30 % measured over an interval of 100 milliseconds. The duration of the sequence shall be adequate for the DFS test purposes.

5.1.3 Test frequencies

Table 8 contains the test frequencies to be used for testing.

Table 8: Test frequencies

Test	clause	Carrier centre frequencies for testing (MHz) (see table 1 of the present document) (see note)		
		Lower sub-band (5 150 MHz to 5 350 MHz)		Higher sub-band 5 470MHz to 5 725 MHz
		5 150 MHz to 5 250 MHz	5 250 MHz to 5 350 MHz	
Carrier frequencies	5.3.2			
Power, power density	5.3.3			
Transmitter unwanted emissions	5.3.4 and 5.3.5	5 180 MHz	5 320 MHz	5 500 MHz, 5 700 MHz
Receiver unwanted emissions	5.3.6			
Transmit Power Control (TPC)	5.3.3	n.a.	5 320 MHz	5 500 MHz, 5 700 MHz
Dynamic Frequency Selection (DFS)	5.3.7	n.a.	One channel within this frequency range	One channel within this sub-band
NOTE: For equipment which is not able to operate on all channels, the test frequencies to be used shall be the lowest and highest frequencies for each of the sub-band(s) declared by the manufacturer.				

5.1.4 Presentation of equipment

5.1.4.1 Integrated and dedicated antennas

The equipment can have either integral antennas or dedicated antennas. Dedicated antennas, further referred to as *dedicated external antennas*, are antennas that are physically external to the equipment and are assessed in combination with the equipment against the requirements in the present document.

NOTE: It should be noted that assessment does not necessarily lead to testing.

An antenna assembly referred to in the present document is understood as the combination of the antenna (integral or dedicated), its coaxial cable and if applicable, its antenna connector and associated switching components .

5.1.4.2 Testing of host connected equipment and plug-in radio devices

For combined equipment and for radio parts for which connection to or integration with host equipment is required to offer functionality to the radio, different alternative test approaches are permitted. Where more than one such combination is intended, testing shall not be repeated for combinations of the radio part and various host equipment where the latter are substantially similar.

Where more than one such combination is intended and the combinations are not substantially similar, one combination shall be tested against all requirements of the present document and all other combinations shall be tested separately for radiated spurious emissions only.

5.1.4.2.1 The use of a host or test jig for testing plug-in radio devices

Where the radio part is a plug-in radio device which is intended to be used within a variety of combinations, a suitable test configuration consisting of either a test jig or a typical host equipment shall be used. This shall be representative for the range of combinations in which the device may be used. The test jig shall allow the radio equipment part to be powered and stimulated as if connected to or inserted into host or combined equipment. Measurements shall be made to all requirements of the present document.

5.1.4.2.2 Testing of combinations

5.1.4.2.2.1 Alternative A: General approach for combinations

Combined equipment or a combination of a plug-in radio device and a specific type of host equipment may be used for testing according to the full requirements of the present document.

5.1.4.2.2.2 Alternative B: For host equipment with a plug-in radio device

A combination of a plug-in radio device and a specific type of host equipment may be used for testing according to the full requirements of the present document.

For radiated spurious emission tests the most appropriate standard shall be applied to the host equipment. The plug-in radio device shall meet the radiated spurious emissions requirements as described in the present document.

5.1.4.2.2.3 Alternative C: For combined equipment with a plug-in radio device

Combined equipment may be used for testing according to the full requirements of the present document.

For radiated spurious emissions the requirements of the most appropriate harmonized EMC standard shall be applied to the non-radio equipment. The plug-in radio device shall meet the radiated spurious emissions requirements as described in the present document.

In the case where the plug-in radio device is totally integrated and cannot operate independently, radiated spurious emissions for the combination shall be tested using the most appropriate harmonized standard with the radio part in receive and/or standby mode. If the frequency range is less than the one defined in the present document, additional measurements according to the requirements in the present document shall be performed to cover the remaining parts of the frequency range. With the radio in transmit mode, the radiated spurious emissions requirements of the present document shall be applied.

5.1.4.2.2.4 Alternative D: For equipment with multiple radios

Multi-radio equipment, where at least one of the radio parts is within the scope of the present document, may be used for testing according to the full requirements of the present document. Additional requirements and limits for multi-radio equipment are set out in the relevant harmonized radio product standards applicable to the other radio parts.

When measuring spurious emissions in the receive and/or standby mode, it is essential that none of the transmitters within the combined equipment are transmitting.

5.1.4.2.2.4.1 The spurious emissions from each radio can be identified

Where the spurious emissions from each radio can be identified, then the spurious emissions from each radio are assessed to the relevant harmonized radio standard.

5.1.4.2.2.4.2 The spurious emissions from each radio cannot be identified

Where the spurious emissions from each radio cannot be identified, then the combined equipment is assessed to the spurious emission requirements contained in all of the relevant harmonized radio standards applicable to the radios contained within the combined product.

Where the applicable harmonized radio standards contain different limits and measuring conditions, then the combined product is assessed to the harmonized radio standard that specifies the least stringent limits for the common part of the frequency measurement ranges. To assess the remaining parts of the frequency measurement ranges the limits from the relevant harmonized radio standard should be used.

5.2 Interpretation of the measurement results

The interpretation of the results recorded in a test report for the measurements described in the present document shall be as follows:

- The measured value related to the corresponding limit will be used to decide whether an equipment meets the requirements of the present document.
- The value of the measurement uncertainty for the measurement of each parameter shall be included in the test report.
- The recorded value of the measurement uncertainty shall be, for each measurement, equal to or lower than the figures in table 9.
- The shared risk approach shall be applied for the interpreting of all measurement results.

For the test methods to determine RF power levels, according to the present document, the measurement uncertainty figures shall be calculated in accordance with TR 100 028-1 [4] and TR 100 028-2 [5] and shall correspond to an expansion factor (coverage factor) $k = 1,96$ or $k = 2$ (which provide confidence levels of respectively 95 % and 95,45 % in the case where the distributions characterizing the actual measurement uncertainties are normal (Gaussian)).

Table 9 is based on such expansion factors.

Table 9: Maximum measurement uncertainty

Parameter	Uncertainty
RF frequency	$\pm 1 \times 10^{-5}$
RF power conducted	$\pm 1,5$ dB
RF power radiated	± 6 dB
Spurious emissions, conducted	± 3 dB
Spurious emissions, radiated	± 6 dB
Humidity	± 5 %
Temperature	± 1 °C
Time	± 10 %

5.3 Essential radio test suites

5.3.1 Product information

The following information shall be stated by the manufacturer in order to carry out the test suites:

- a) The occupied channel bandwidth(s).
- b) The DFS operating modes in which the equipment can operate (master, slave with radar detection, slave without radar detection).
- c) Whether or not the device can operate in ad-hoc mode, and if so, the operating frequency range when operating in ad-hoc mode.
- d) The operating frequency range(s) of the equipment.
- e) Whether or not the device has a TPC feature containing one or more TPC ranges.

NOTE: The equipment can have more than one TPC range to accommodate different antennas and/or the different applicable power limits.

- f) For equipment that has a TPC feature, for each TPC range:
 - The lowest and highest transmitter output power level (or lowest and highest eirp level in case of integrated antenna equipment).

- The intended antenna assembly(ies), their corresponding gain(s), the resulting eirp values and the corresponding DFS threshold level(s).
 - The applicable operating frequency range(s).
- g) For equipment that has no TPC feature:
- The maximum transmitter output power level (or maximum eirp level in case of integrated antenna equipment).
 - The intended antenna assembly(ies), their corresponding gain(s), the resulting eirp values and the corresponding DFS threshold level(s).
- h) The normal and the extreme operating conditions (e.g. voltage and temperature) that apply to the equipment.
- i) The test sequence(s) used by the UUT.

5.3.2 Carrier frequencies

5.3.2.1 Test conditions

These measurements shall be performed under both normal and extreme test conditions (see clause 5.1.1).

The frequencies at which the conformance requirements in clause 4.2 shall be verified are defined in clause 5.1.3.

The UUT shall be configured to operate at a normal RF power output level.

For a UUT with antenna connector(s) and using dedicated external antenna(s), or for a UUT with integral antenna(s) but with a temporary antenna connector provided, conducted measurements shall be used.

For a UUT with integral antenna(s) and without a temporary antenna connector, radiated measurements shall be used.

5.3.2.2 Test methods

5.3.2.2.1 Conducted measurement

5.3.2.2.1.1 Equipment operating without modulation

This test method requires that the UUT can be operated in an unmodulated test mode.

The UUT shall be connected to a frequency counter and operated in an unmodulated mode. The result shall be recorded.

5.3.2.2.1.2 Equipment operating with modulation

This method is an alternative to the above method in case the UUT can not be operated in an un-modulated mode.

The UUT shall be connected to spectrum analyser.

The settings of the spectrum analyser shall be adjusted to optimize the instruments frequency accuracy.

Max Hold shall be selected and the centre frequency adjusted to that of the UUT.

The peak value of the power envelope shall be measured and noted. The span shall be reduced and the marker moved in a positive frequency increment until the upper, (relative to the centre frequency), -10 dBc point is reached. This value shall be noted as f1.

The marker shall then be moved in a negative frequency increment until the lower, (relative to the centre frequency), -10 dBc point is reached. This value shall be noted as f2.

The centre frequency is calculated as $(f1 + f2) / 2$.

5.3.2.2.2 Radiated measurement

The test set up as described in annex B shall be used with a spectrum analyser of sufficient accuracy attached to the test antenna (see clause 5.2).

The test procedure is as described under clause 5.3.2.2.1.

5.3.3 RF output power, Transmit Power Control (TPC) and power density

5.3.3.1 Test conditions

The conformance requirements in clause 4.3 shall be verified at those carrier centre frequencies defined in clause 5.1.3 and for each of the TPC ranges declared by the manufacturer.

The measurements shall be performed using normal operation of the equipment with test signal applied (see clause 5.1.2.1).

NOTE: Special test functions may be needed in the UUT to make this test possible.

For a UUT with antenna connector(s) and using dedicated external antenna(s), or for a UUT with integral antenna(s) but with a temporary antenna connector provided, conducted measurements shall be used in conjunction with the stated antenna assembly gain(s).

For a UUT with integral antenna(s) and without a temporary antenna connector, radiated measurements shall be used.

5.3.3.2 Test method

5.3.3.2.1 Conducted measurement

5.3.3.2.1.1 RF output power at the highest power level

These measurements shall be performed under both normal and extreme test conditions (see clause 5.1.1).

The UUT shall be configured to operate at:

- the highest stated transmitter output power level of the TPC range; or
- the maximum stated transmitter output power level in case the equipment has not TPC feature.

Step 1:

- a) Using suitable attenuators, the output power of the transmitter shall be coupled to a matched diode detector or equivalent thereof. The output of the diode detector shall be connected to the vertical channel of an oscilloscope.
- b) The combination of the diode detector and the oscilloscope shall be capable of faithfully reproducing the duty cycle of the transmitter output signal.
- c) The observed duty cycle of the transmitter (Tx on / (Tx on + Tx off)) shall be noted as x ($0 < x \leq 1$), and recorded in the test report. For the purpose of testing, the equipment shall be operated with a duty cycle that is equal to or greater than 0,1 (see clause 5.1.2).

Step 2:

- a) The RF output power of the transmitter when operating at the highest power level shall be determined using a wideband calibrated RF power meter with a matched thermocouple detector or an equivalent thereof and with an integration period that exceeds the repetition period of the transmitter by a factor 5 or more. The observed value shall be noted as "A" (in dBm).

- b) The EIRP shall be calculated from the above measured power output A (in dBm) the observed duty cycle x, and the stated antenna gain "G" in dBi, according to the formula in c). If more than one antenna assembly is intended for this power setting or TPC range, the gain of the antenna assembly with the highest gain shall be used.
- c) $P_H = A + G + 10 \log (1/x)$ (dBm).
- d) P_H shall be recorded in the test report.

5.3.3.2.1.2 RF output power at the lowest power level of the TPC range

The UUT shall be configured to operate at the lowest stated transmitter output power level of the TPC range.

Step 1:

- a) Using suitable attenuators, the output power of the transmitter shall be coupled to a matched diode detector or equivalent thereof. The output of the diode detector shall be connected to the vertical channel of an oscilloscope.
- b) The combination of the diode detector and the oscilloscope shall be capable of faithfully reproducing the duty cycle of the transmitter output signal.
- c) The observed duty cycle of the transmitter (Tx on / (Tx on + Tx off)) shall be noted as x ($0 < x \leq 1$), and recorded in the test report. For the purpose of testing, the equipment shall be operated with a duty cycle that is equal to or greater than 0,1 (see clause 5.1.2).

Step 2:

- a) The RF output power of the transmitter when operating at the lowest power level of the TPC range shall be determined using a wideband calibrated RF power meter with a matched thermocouple detector or an equivalent thereof and with an integration period that exceeds the repetition period of the transmitter by a factor 5 or more. The observed value shall be noted as "A" (in dBm).
- b) The EIRP shall be calculated from the above measured power output A (in dBm) the observed duty cycle x, and the stated antenna gain "G" in dBi, according to the formula in c). If more than one antenna assembly is intended for this TPC range, the gain of the antenna assembly with the highest gain shall be used.
- c) $P_L = A + G + 10 \log (1/x)$ (dBm).
- d) P_L shall be recorded in the test report.

5.3.3.2.1.3 Power density

The UUT shall be operated as described in clause 5.3.3.2.1.1. Furthermore, for the purpose of this test, the minimum transmitter on-time should be 10 μ s.

In the case of radiated measurements, using a test site as described in annex B and applicable measurement procedures as described in annex C, the power density as defined in clause 4.3.1 shall be measured and recorded.

The transmitter shall be connected to the measuring equipment via a suitable attenuator and the power density as defined in clause 4.3.1 shall be measured and recorded.

The power density shall be determined using a spectrum analyser of adequate bandwidth in combination with an RF power meter.

Connect an RF power meter to the narrow IF output of the spectrum analyser and correct its reading using a known reference source, e.g. a signal generator.

NOTE: The IF output of the spectrum analyser may be 20 dB or more below the input level of the spectrum analyser. Unless the power meter has adequate sensitivity, a wideband amplifier may be required.

The test procedure shall be as follows:

Step 1:

- The measurement set-up shall be calibrated with a CW signal from a calibrated source; the reference signal shall be set to a level equal to the value for the applicable limit for eirp power density (reduced by the highest applicable antenna gain) and at a frequency equal to the centre frequency of the channel being tested.
- The settings of the spectrum analyser shall be:
 - centre Frequency: equal to the signal source;
 - resolution BW: 1 MHz;
 - video BW: 1 MHz;
 - detector mode: positive peak;
 - averaging: off;
 - span: zero Hz;
 - reference level: equal to the level of the reference signal.

Step 2:

- The calibrating signal power shall be reduced by 10 dB and it shall be verified that the power meter reading also reduces by 10 dB.

Step 3:

- Connect the UUT. Using the following settings of the spectrum analyser in combination with "max hold" function, find the frequency of highest power output in the power envelope:
 - centre Frequency: equal to operating frequency;
 - resolution BW: no change to the setting in step 1;
 - video BW: no change to the setting in step 1;
 - detector mode: no change to the setting in step 1;
 - averaging: no change to the setting in step 1;
 - span: 1,5 times the spectrum width;
 - reference level: no change to the setting in step 1.
- The frequency found shall be recorded.
- The centre frequency of the spectrum analyser shall be set to the recorded frequency, the span shall be further reduced to 1 MHz and the frequency of the highest power output shall be found. If this frequency is different from the previous recorded frequency, the new frequency shall be recorded.

Step 4:

- Set the centre frequency of the spectrum analyser to the found frequency and switch to zero span. The power meter indicates the measured power density (D). The mean power density EIRP is calculated from the above measured power density (D), the observed duty cycle x (see clause 5.3.3.2.1.1, step 1), and the applicable antenna assembly gain "G" in dBi, according to the formula below. If more than one antenna assembly is intended for this power setting or TPC range, the gain of the antenna assembly with the highest gain shall be used:
 - $PD = D + G + 10 \log (1/x)$;
 - PD shall be recorded in the test report.

The above procedure shall be repeated for each of the frequencies identified in clause 5.1.3.

Where the spectrum analyser bandwidth is non-Gaussian, a suitable correction factor shall be determined and applied.

Where a spectrum analyser is equipped with a facility to measure power density, this facility may be used instead of the above procedure to measure the power density across the occupied channel bandwidth.

5.3.3.2.2 Radiated measurement

The test set up as described in annexes B and the applicable measurements procedures described in annex C shall be used (see clause 5.2).

The test procedure is as described under clause 5.3.3.2.1.

5.3.4 Transmitter unwanted emissions outside the 5 GHz RLAN bands

5.3.4.1 Test conditions

The conformance requirements in clause 4.4.1 shall be verified under normal operating conditions, and at those carrier centre frequencies defined in clause 5.1.3. The UUT shall be configured to operate at the highest stated power level.

For UUT without an integral antenna and for a UUT with an integral antenna but with a temporary antenna connector, one of the following options shall be used:

- the level of unwanted emissions shall be measured as their power in a specified load (conducted spurious emissions) and their effective radiated power when radiated by the cabinet or structure of the equipment with the antenna connector terminated by a specified load (cabinet radiation); or
- the level of unwanted emissions shall be measured as their effective radiated power when radiated by cabinet and antenna.

In the case where the UUT has an integral antenna, but no temporary antenna connector, only radiated measurements shall be used.

5.3.4.2 Test method

5.3.4.2.1 Conducted measurement

The UUT shall be connected to a spectrum analyser capable of RF power measurements. The test procedure shall be as follows:

- a) The settings of the spectrum analyser shall be as follows:
 - sensitivity: at least 6 dB below the limit given in table 4;
 - video bandwidth: 1 MHz;
 - video averaging on, or peak hold.

The video signal of the spectrum analyser shall be "gated" such that the spectrum measured shall be measured between 4,0 μ s before the start of the burst to 4,0 μ s after the end of the burst.

NOTE: The "start of the burst" is the centre of the first sample of the preamble heading the burst. The "end of the burst" is the centre of the last sample in the burst.

This gating may be analogue or numerical, dependent upon the design of the spectrum analyser:

b) Initially the power level shall be measured in the ranges:

- 47 MHz to 74 MHz;
- 87,5 MHz to 118 MHz;
- 174 MHz to 230 MHz;
- 470 MHz to 862 MHz;

with a resolution bandwidth of 1 MHz and in a frequency scan mode.

c) If any measurement is greater than -54 dBm then measurements shall be taken with a resolution bandwidth of 100 kHz, zero frequency scan, at the 11 frequencies spaced 100 kHz apart in a band $\pm 0,5$ MHz centred on the failing frequency.

EXAMPLE 1: A UUT fails at 495 MHz. Measurements are made in a 100 kHz bandwidth on 494,5 MHz, 494,6 MHz, 494,7 MHz, etc. up to 495,5 MHz.

d) Initially the power level shall be measured in the ranges:

- 25 MHz to 47 MHz;
- 74 MHz to 87,5 MHz;
- 118 MHz to 174 MHz;
- 230 MHz to 470 MHz;
- 862 MHz to 1 GHz;

with a resolution bandwidth of 1 MHz and in a frequency scan mode.

e) If any measurement in d) is greater than -36 dBm, then measurements shall be taken with a resolution bandwidth of 100 kHz, zero frequency scan, at the 11 frequencies spaced 100 kHz apart in a band $\pm 0,5$ MHz centred on the failing frequency.

EXAMPLE 2: A UUT fails at 285 MHz. Measurements are made in a 100 kHz bandwidth on 284,5 MHz, 284,6 MHz, 284,7 MHz, etc. up to 285,5 MHz.

f) The power level shall be measured in the ranges

- 1 GHz to 5,15 GHz;
- 5,725 GHz to 26,5 GHz;

with a resolution bandwidth of 1 MHz and in a frequency scan mode.

g) The power level shall be measured in the range:

- 5,35 GHz to 5,47 GHz;

with a resolution bandwidth of 1 MHz with zero frequency scan.

5.3.4.2.2 Radiated measurement

The test set up as described in annex B shall be used with a spectrum analyser of sufficient accuracy attached to the test antenna (see clause 5.2).

The test procedure is as described under clause 5.3.4.2.1.

5.3.5 Transmitter unwanted emissions within the 5 GHz RLAN bands

5.3.5.1 Test conditions

The conformance requirements in clause 4.4.2 shall be verified under normal operating conditions, and at those carrier centre frequencies defined in clause 5.1.3. The UUT shall be configured to operate at the highest stated conducted RF power level or highest eirp level in case of integral antenna equipment.

For UUT without an integral antenna and for a UUT with an integral antenna but with a temporary antenna connector, one of the following options shall be used:

- the level of unwanted emissions shall be calculated from their measured power in a specified load (conducted spurious emissions) and their effective radiated power when radiated by the cabinet or structure of the equipment with the antenna connector terminated by a specified load (cabinet radiation); or
- the level of unwanted emissions shall be measured as their effective radiated power when radiated by cabinet and antenna.

In the case where the UUT has an integral antenna, but no temporary antenna connector, only radiated measurements shall be used.

5.3.5.2 Test method

5.3.5.2.1 Conducted measurement

The settings of the spectrum analyser shall be as follows:

- resolution bandwidth: 1 MHz;
- video bandwidth: 30 kHz;
- video averaging on.

The video signal of the spectrum analyser shall be "gated" such that the spectrum measured shall be measured between 4,0 μ s before the start of the burst to 4,0 μ s after the end of the burst.

NOTE: The "start of the burst" is the centre of the first sample of the preamble heading the burst. The "end of the burst" is the centre of the last sample in the burst.

This gating may be analogue or numerical, dependent upon the design of the spectrum analyser.

Determination of the reference average power level

The spectrum analyser shall be tuned to measurement frequencies at every 1 MHz interval within $f_c - 9$ MHz to $f_c + 9$ MHz, with zero frequency scan. The maximum average power within $f_c - 9$ MHz to $f_c + 9$ MHz (except f_c) is the reference level for relative power measurements on the channel centred at f_c and shall be recorded to compute relative power levels as described below.

Determination of the relative average power levels

The power level shall be measured in the ranges:

- 5 150 MHz to 5 350 MHz;
- 5 470 MHz to 5 725 MHz;

excluding the interval $f_c - 9$ MHz to $f_c + 9$ MHz with a resolution bandwidth of 1 MHz and in a frequency scan mode. The average value of power relative to the reference average power level for the channel shall be noted.

5.3.5.2.2 Radiated measurement

The test set up as described in annex B shall be used with a spectrum analyser of sufficient accuracy attached to the test antenna (see clause 5.2).

The test procedure is as described under clause 5.3.5.2.1.

5.3.6 Receiver spurious emissions

5.3.6.1 Test conditions

The conformance requirements in clause 4.5 shall be verified under normal operating conditions, and at those carrier centre frequencies defined in clause 5.1.3.

For UUT without an integral antenna and for a UUT with an integral antenna but with a temporary antenna connector, one of the following options shall be used:

- the level of unwanted emissions shall be measured as their power in a specified load (conducted spurious emissions) and their effective radiated power when radiated by the cabinet or structure of the equipment with the antenna connector terminated by a specified load (cabinet radiation); or
- the level of unwanted emissions shall be measured as their effective radiated power when radiated by cabinet and antenna.

In the case where the UUT has an integral antenna, but no temporary antenna connector, only radiated measurements shall be used.

Test sequence (see clause 5.1.2.1) shall be applied to the receiver input at the reference sensitivity level according to the nominal bit rate.

5.3.6.2 Test method

5.3.6.2.1 Conducted measurement

Using a directional coupler, circulator or gating to remove the test data transmissions (and/or other means to isolate the emissions measurements instrument from the test data signals transmitted) the radio emissions from the UUT shall be measured while the UUT receives test data.

The settings of the spectrum analyser shall be as follows:

- frequency scan allowed;
- resolution bandwidth: 1 MHz or 100 kHz;
- video bandwidth: 1 MHz;
- video averaging on, or peak hold.

Tuning the spectrum analyser centre frequency over the measurement frequency bands specified in table 5, the power level of UUT receiver emissions shall be measured during test data transmissions. If gating is used to remove the unwanted energy from the test data transmissions, the tuning of the spectrum analyser shall not change during the gated-out time interval.

5.3.6.2.2 Radiated measurement

The test set up as described in annex B shall be used with a spectrum analyser of sufficient accuracy attached to the test antenna (see clause 5.2).

The test procedure is as described under clause 5.3.6.2.1.

5.3.7 Dynamic Frequency Selection (DFS)

5.3.7.1 Test conditions

The conformance requirements in clause 4.6 shall be verified under normal operating conditions and at those carrier centre frequencies defined in clause 5.1.3.

Some of the tests may be facilitated by disabling the *Non-Occupancy Period* as well as the channel selection mechanism for the *Uniform Spreading* requirement.

It should be noted that once a UUT is powered on, it will not start its normal operating functions immediately, as it will have to finish its power-up cycle first ($T_{\text{power_up}}$). As such, the UUT, as well as any other device used in the set-up, may be equipped with a feature that will indicate its status during the testing, e.g. power-up mode, normal operation mode, channel check status, radar detection event, etc.

5.3.7.1.1 Selection of radar test signals

The radar test signals to be used during the DFS testing are defined in table D.4.

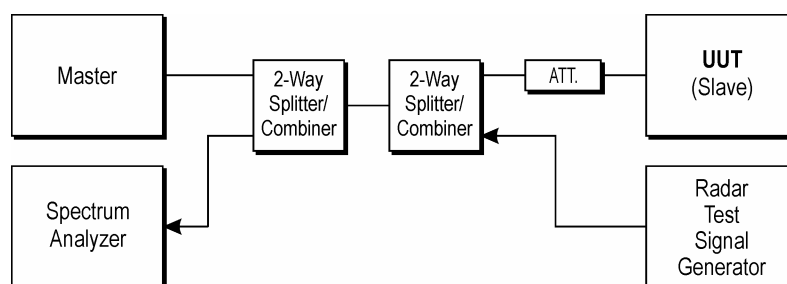

Figure 5: Set-up B

5.3.7.1.2.3 Set-up C

The UUT is a RLAN device operating in slave mode with Radar Interference Detection function. Radar test signals are injected into the slave device. This set-up also contains a RLAN device operating in master mode. The UUT (slave device) is associated with the master device.

Figure 6 shows an example for *Set-up C*. The set-up used shall be documented in the test report.

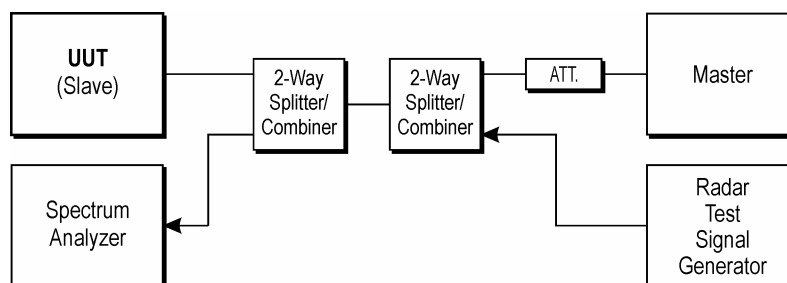

Figure 6: Set-up C

5.3.7.2 Test Method

5.3.7.2.1 Conducted measurement

For a UUT with antenna connector(s) and using dedicated external antenna(s), or for a UUT with integral antenna(s) but with a temporary antenna connector provided, conducted measurements shall be used.

The UUT shall be configured to operate at the highest transmitter output power setting.

If the UUT has a Radar Interference Detection function, the output power of the signal generator producing the radar test signals, as selected using clause 5.3.7.1.1, shall (unless otherwise specified) provide a received signal power at the antenna connector of the UUT with a level equal to (*Interference Detection Threshold* + G), see tables D.2 and D.3. Parameter G [dBi] corresponds to the gain of the antenna assembly stated by the manufacturer. If more than one antenna assembly is intended for this power setting, the gain of the antenna assembly with the lowest gain shall be used.

A channel shall be selected in accordance with clause 5.1.3. This channel is designated as Ch_r (channel occupied by a radar). The UUT shall be configured to select Ch_r as the first *Operating Channel*.

5.3.7.2.1.1 Channel Availability Check

The clauses below define the procedure to verify the *Channel Availability Check* and the *Channel Availability Check Time* ($T_{ch_avail_check}$) by ensuring that the UUT is capable of detecting radar pulses at the beginning and at the end of the *Channel Availability Check Time*.

5.3.7.2.1.1.1 Tests with a radar burst at the beginning of the Channel Availability Check Time

The steps below define the procedure to verify the radar detection capability on the selected channel when a radar burst occurs at the beginning of the *Channel Availability Check Time*.

- a) The signal generator and UUT are connected using *Set-up A* as described in clause 5.3.7.1.2.1 and the power of the UUT is switched off.
- b) The UUT is powered on at T_0 . T_1 denotes the instant when the UUT has completed its power-up sequence ($T_{\text{power_up}}$) and is ready to start the radar detection. The *Channel Availability Check* is expected to commence on Ch_r at instant T_1 and is expected to end no sooner than $T_1 + T_{\text{ch_avail_check}}$ unless a radar is detected sooner.

NOTE: Additional verification may be needed to define T_1 in case it is not exactly known or indicated by the UUT.

- c) A radar burst is generated on Ch_r using radar test signal #1 defined in table D.4 at a level of 10 dB above the level defined in clause 5.3.7.2.1. This single-burst radar test signal shall commence within 2 sec after time T_1 .
- d) It shall be recorded if the radar test signal was detected.
- e) A timing trace or description of the observed timing and behaviour of the UUT shall be recorded.

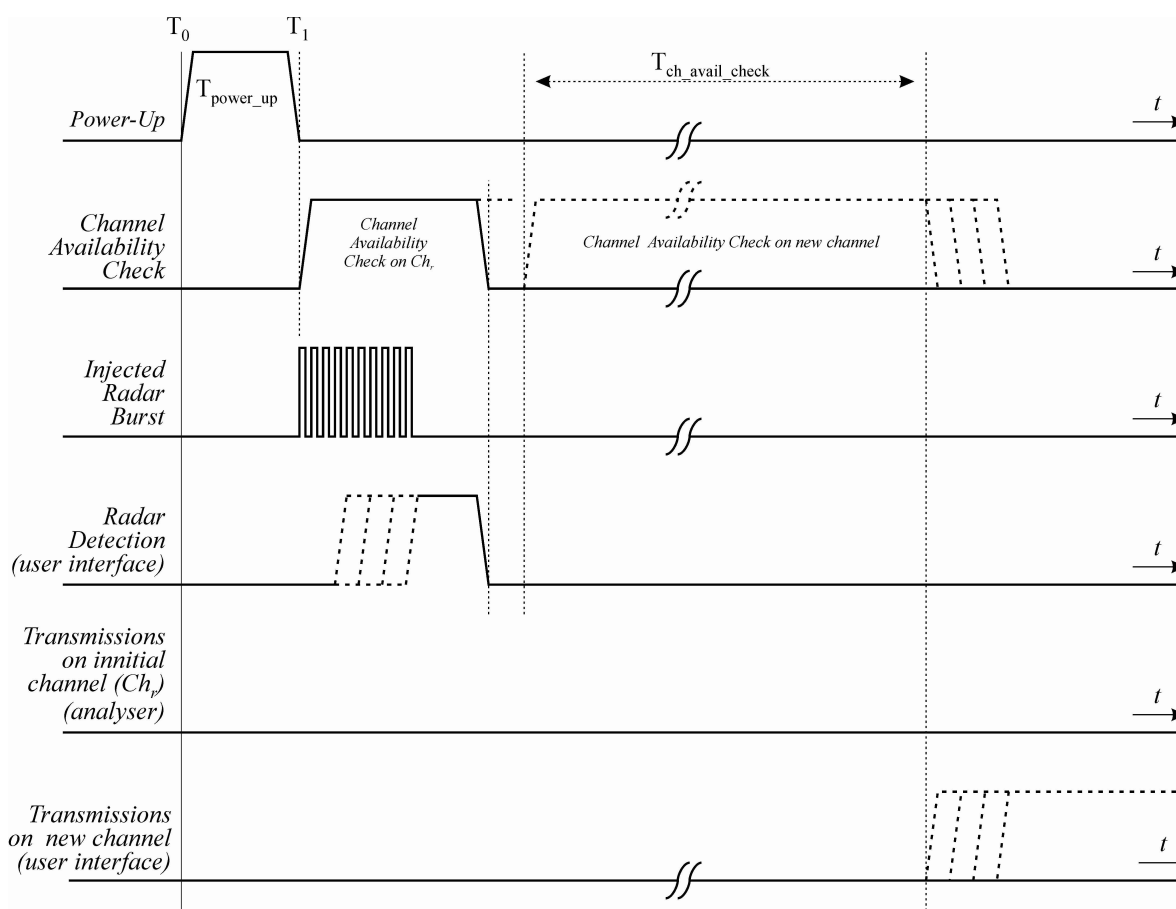

Figure 7: Example of timing for radar testing at the beginning of the Channel Availability Check Time

5.3.7.2.1.1.2 Tests with radar burst at the end of the Channel Availability Check Time

The steps below define the procedure to verify the radar detection capability on the selected channel when a radar burst occurs at the end of the *Channel Availability Check Time*:

- a) The signal generator and UUT are connected using *Set-up A* described in clause 5.3.7.1.2.1 and the power of the UUT is switched off.

- b) The UUT is powered up at T_0 . T_1 denotes the instant when the UUT has completed its power-up sequence ($T_{\text{power_up}}$) and is ready to start the radar detection. The *Channel Availability Check* is expected to commence on Ch_I at instant T_1 and is expected to end no sooner than $T_1 + T_{\text{ch_avail_check}}$ unless a radar is detected sooner.

NOTE: Additional verification may be needed to define T_1 in case it is not exactly known or indicated by the UUT.

- c) A radar burst is generated on Ch_I using radar test signal #1 defined in table D.4 at a level of 10 dB above the level defined in clause 5.3.7.2.1. This single-burst radar test signal shall commence towards the end of the minimum required *Channel Availability Check Time* but not before time $T_1 + T_{\text{ch_avail_check}} - 2$ [sec].
- d) It shall be recorded if the radar test signal was detected.
- e) A timing trace or description of the observed timing and behaviour of the UUT shall be recorded.

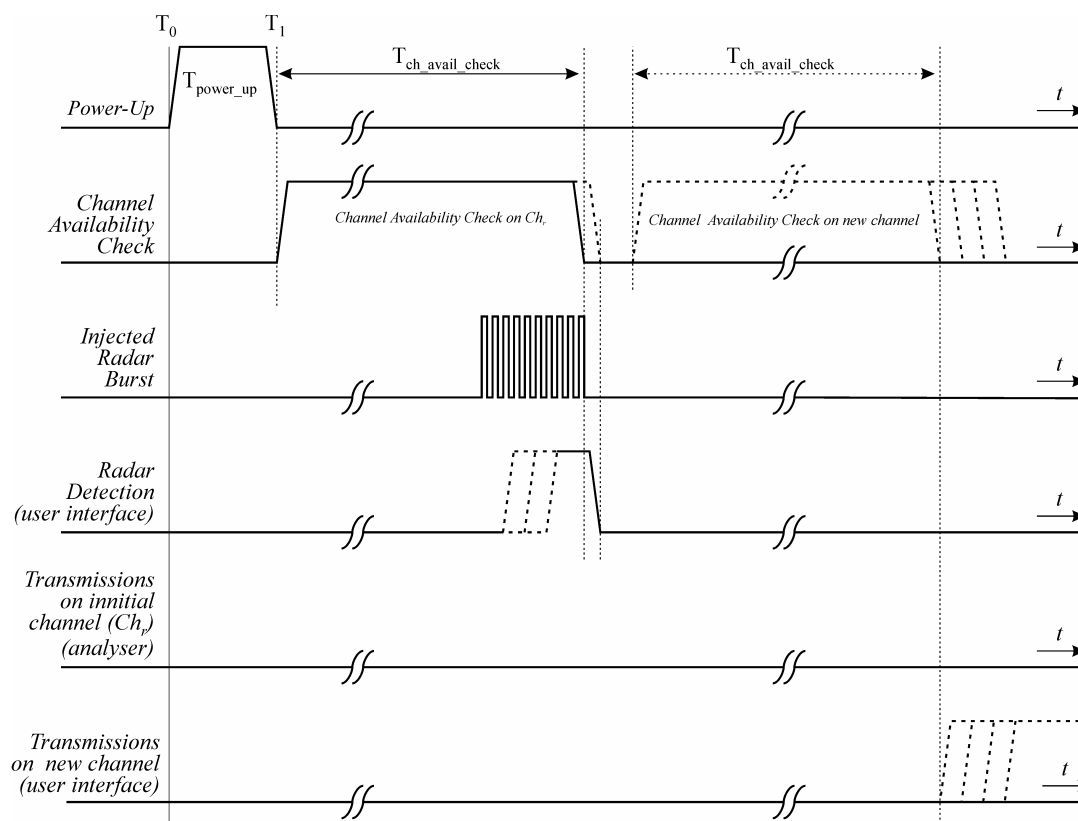

Figure 8: Example of timing for radar testing towards the end of the Channel Availability Check Time

5.3.7.2.1.2 Interference Detection Threshold (during the Channel Availability Check)

The different steps below define the procedure to verify the *Interference Detection Threshold* during the *Channel Availability Check Time*.

- a) The signal generator and UUT are connected using *Set-up A* described in clause 5.3.7.1.2.1 and the power of the UUT is switched off.
- b) The UUT is powered on at T_0 . T_1 denotes the instant when the UUT has completed its power-up sequence ($T_{\text{power_up}}$) and is ready to start the radar detection. The *Channel Availability Check* is expected to commence on Ch_I at instant T_1 and is expected to end no sooner than $T_1 + T_{\text{ch_avail_check}}$ unless a radar is detected sooner.

NOTE: Additional verification may be needed to define T_1 in case it is not exactly known or indicated by the UUT.

- c) A radar burst is generated on Ch_r using radar test signal #1 defined in table D.4 at a level defined in clause 5.3.7.2.1. This single-burst radar signal shall commence at approximately 10 seconds after T_1 .
- d) It shall be recorded if the radar test signal was detected.
- e) The steps c) to d) shall be repeated at least 20 times in order to determine the detection probability for the selected radar test signal. The detection probability shall be compared with the limit specified in table D.4.
- f) The steps c) to e) shall be repeated for each of the radar test signals defined in table D.4 and as described in clause 5.3.7.1.1.

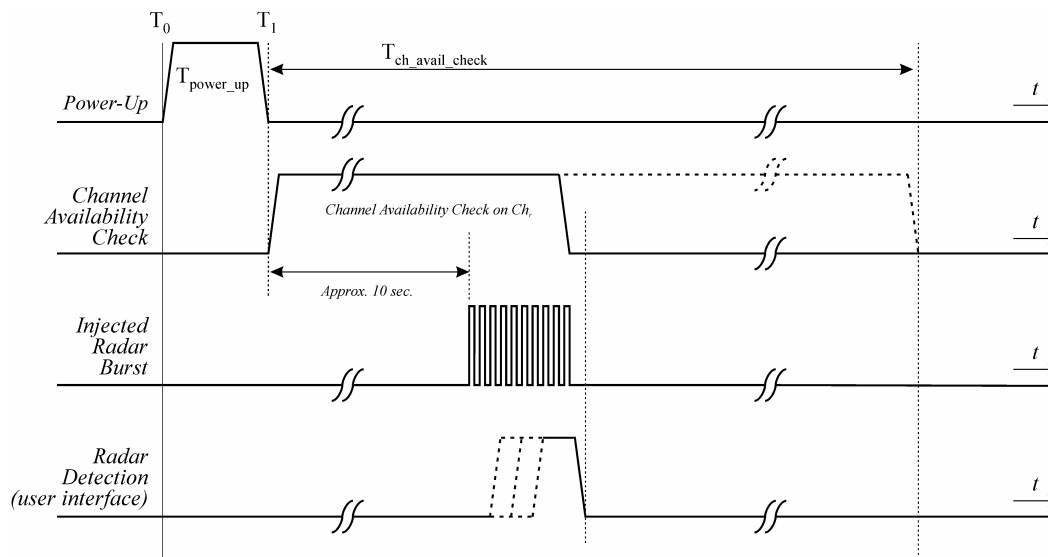

Figure 9: Example of timing for radar testing during the Channel Availability Check

5.3.7.2.1.3 In-Service Monitoring

The steps below define the procedure to verify the *In-Service Monitoring* and the *Interference Detection Threshold* during the *In-Service Monitoring*.

- a) When the UUT is a master device, a slave device will be used that associates with the UUT. The signal generator and the UUT are connected using *Set-up A* described in clause 5.3.7.1.2.1.
When the UUT is a slave device with a Radar Interference Detection function, the UUT shall associate with a master device. The signal generator and the UUT are connected using *Set-up C* described in clause 5.3.7.1.2.3.
- b) The UUT shall transmit a test transmission sequence in accordance with clause 5.1.2.2 on the selected channel Ch_r .
- c) At a certain time T_0 , a radar burst is generated on Ch_r using radar test signal #1 defined in table D.4 and at a level defined in clause 5.3.7.2.1. T_1 denotes the end of the radar burst.
- d) It shall be recorded if the radar test signal was detected.
- e) The steps b) to d) shall be repeated at least 20 times in order to determine the detection probability for the selected radar test signal. The detection probability shall be compared with the limit specified in table D.4.
- f) The steps b) to e) shall be repeated for each of the radar test signals defined in table D.4 and as described in clause 5.3.7.1.1.

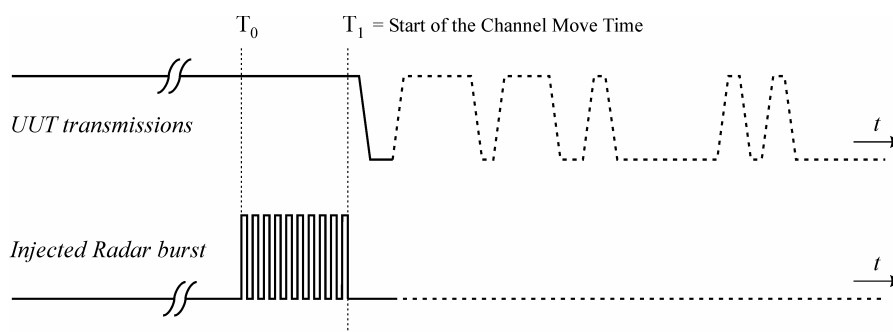

Figure 10: Example of timing for radar testing during In-Service Monitoring

5.3.7.2.1.4 Channel Shutdown and Non-Occupancy period

The steps below define the procedure to verify the *Channel Shutdown* process and to determine the *Channel Closing Transmission Time*, the *Channel Move Time* and the *Non-Occupancy Period*.

- a) When the UUT is a master device, a slave device will be used that associates with the UUT. The signal generator and the UUT shall be connected using *Set-up A* described in clause 5.3.7.1.2.1.

When the UUT is a slave device (with or without a Radar Interference Detection function), the UUT shall associate with a master device. The signal generator and the UUT shall be connected using *Set-up B* described in clause 5.3.7.1.2.2.

In both cases, it is assumed that the channel selection mechanism for the *Uniform Spreading* requirement is disabled in the master.
 - b) The UUT shall transmit a test transmission sequence in accordance with clause 5.1.2.2 on the selected channel Ch_r .
 - c) At a certain time T_0 , a radar burst is generated on Ch_r using radar test signal #1 defined in table D.4 and at a level of 10 dB above the level defined in clause 5.3.7.2.1 on the selected channel. T_1 denotes the end of the radar burst.
 - d) The transmissions of the UUT following instant T_1 on the selected channel shall be observed for a period greater than or equal to the *Channel Move Time* defined in table D.1. The aggregate duration (*Channel Closing Transmission Time*) of all transmissions from the UUT during the *Channel Move Time* shall be compared to the limit defined in table D.1.
- NOTE: The aggregate duration of all transmissions of the UUT does not include quiet periods in between transmissions of the UUT.
- e) T_2 denotes the instant when the UUT has ceased all transmissions on the channel. The time difference between T_1 and T_2 shall be measured. This value (*Channel Move Time*) shall be noted and compared with the limit defined in table D.1.
 - f) When the UUT is a master device, following instant T_2 , the selected channel shall be observed for a period equal to the *Non-Occupancy Period* ($T_3 - T_2$) to verify that the UUT does not resume any transmissions on this channel.
 - g) When the UUT is a slave device with a Radar Interference Detection function the steps b) to e) shall be repeated with the generator connected to the UUT using *Set-up C* as described in clause 5.3.7.1.2.3. See also table D.3.

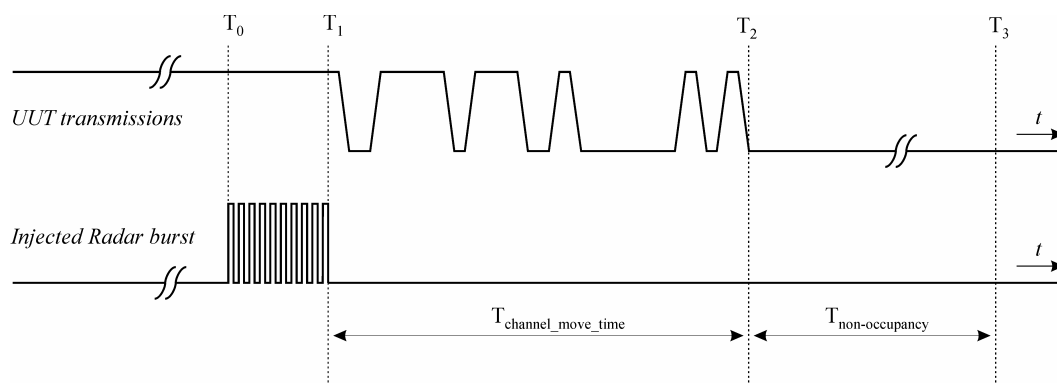

Figure 11: Channel Closing Transmission Time, Channel Move Time and Non-Occupancy Period

5.3.7.2.2 Radiated measurement

For a UUT with integral antenna(s) and without temporary antenna connector, radiated measurements shall be used.

If the UUT has a Radar Interference Detection function, the output power of the signal generator shall (unless otherwise specified) provide a signal power at the antenna of the UUT with a level equal to *Interference Detection Threshold* (table D.2, table D.3).

The test set up as described in annex B and applicable measurement procedures as described in annex C shall be used to test the different DFS features of the UUT. The test procedure is further as described under clause 5.3.7.2.1.

Annex A (normative): The EN Requirements Table (EN-RT)

Notwithstanding the provisions of the copyright clause related to the text of the present document, ETSI grants that users of the present document may freely reproduce the EN-RT proforma in this annex so that it can be used for its intended purposes and may further publish the completed EN-RT.

The EN Requirements Table (EN-RT) serves a number of purposes, as follows:

- It provides a tabular summary of all the requirements.
- It shows the status of each EN-R, whether it is essential to implement in all circumstances (Mandatory), or whether the requirement is dependent on the supplier having chosen to support a particular optional service or functionality (Optional). In particular it enables the EN-Rs associated with a particular optional service or functionality to be grouped and identified.
- When completed in respect of a particular equipment it provides a means to undertake the static assessment of conformity with the EN.

Table A.1: EN Requirements Table (EN-RT)

EN Reference		EN 301 893				Comment
No.	Reference	EN-R (see note)	Status			
1	4.2	Carrier frequencies	M			
2	4.3	RF output power, Transmit Power Control (TPC): and power density	M			
3	4.4.1	Transmitter unwanted emissions outside the 5 GHz RLAN bands	M			
4	4.4.2	Transmitter unwanted emissions within the 5 GHz RLAN bands	M			
5	4.5	Receiver spurious emissions	M			
6	4.6	Dynamic Frequency Selection (DFS)	M			

NOTE: These EN-Rs are justified under article 3.2 of the R&TTE Directive [1].

Key to columns:

No: table entry number;

Reference: clause reference number of conformance requirement within the present document;

EN-R: title of conformance requirement within the present document;

Status: status of the entry as follows:

M Mandatory, shall be implemented under all circumstances;

O Optional, may be provided, but if provided shall be implemented in accordance with the requirements;

O.n this status is used for mutually exclusive or selectable options among a set. The integer "n" shall refer to a unique group of options within the EN-RT. A footnote to the EN-RT shall explicitly state what the requirement is for each numbered group. For example, "It is mandatory to support at least one of these options", or, "It is mandatory to support exactly one of these options".

Comments: To be completed as required.

Annex B (normative): Test sites and arrangements for radiated measurements

B.1 Test sites

B.1.1 Open air test sites

The term "open air" should be understood from an electromagnetic point of view. Such a test site may be really in open air or alternatively with walls and ceiling transparent to the radio waves at the frequencies considered.

An open air test site may be used to perform the measurements using the radiated measurement methods described in clause 5. Absolute or relative measurements may be performed on transmitters or on receivers; absolute measurements of field strength require a calibration of the test site. Above 1 GHz, measurements should be done in anechoic conditions. This may be met by semi anechoic sites provided reflections are avoided.

For measurements at frequencies below 1 GHz, a measurement distance appropriate to the frequency shall be used. For frequencies above 1 GHz, any suitable measuring distance may be used. The equipment size (excluding the antenna) shall be less than 20 % of the measuring distance. The height of the equipment or of the substitution antenna shall be 1,5 m; the height of the test antenna (transmit or receive) shall vary between 1 m and 4 m.

Sufficient precautions shall be taken to ensure that reflections from extraneous objects adjacent to the site do not degrade the measurement results, in particular:

- No extraneous conducting objects having any dimension in excess of a quarter wavelength of the highest frequency tested shall be in the immediate vicinity of the site according to CISPR 16-1 [6].
- All cables shall be as short as possible; as much of the cables as possible shall be on the ground plane or preferably below; and the low impedance cables shall be screened.

The general measurement arrangement is shown in figure B.1.

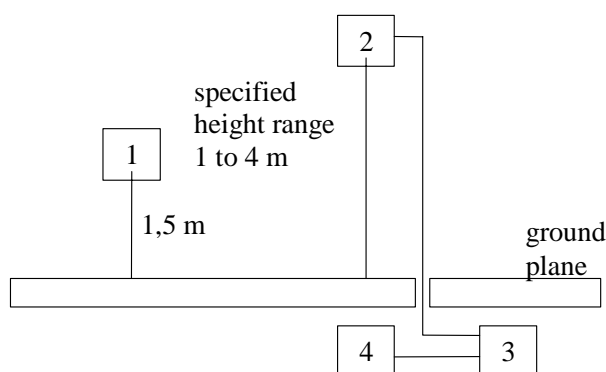

- 1: Equipment under test.
- 2: Test antenna.
- 3: High pass filter (as required).
- 4: Spectrum analyser or measuring receiver.

Figure B.1: Measuring arrangement

B.1.2 Anechoic chamber

B.1.2.1 General

An anechoic chamber is a well shielded chamber covered inside with radio frequency absorbing material and simulating a free space environment. It is an alternative site on which to perform the measurements using the radiated measurement methods described in clause 5.7. Absolute or relative measurements may be performed on transmitters or on receivers. Absolute measurements of field strength require a calibration of the anechoic chamber. The test antenna, equipment under test and substitution antenna are used in a way similar to that at the open air test site, but are all located at the same fixed height above the floor.

B.1.2.2 Description

An anechoic chamber should meet the requirements for shielding loss and wall return loss as shown in figure B.2. Figure B.3 shows an example of the construction of an anechoic chamber having a base area of 5 m by 10 m and a height of 5 m. The ceiling and walls are coated with pyramidically formed absorbers approximately 1 m high. The base is covered with special absorbers which form the floor. The available internal dimensions of the chamber are 3 m × 8 m × 3 m, so that a maximum measuring distance of 5 m in the middle axis of this chamber is available. The floor absorbers reject floor reflections so that the antenna height need not be changed. Anechoic chambers of other dimensions may be used.

B.1.2.3 Influence of parasitic reflections

For free-space propagation in the far field, the relationship of the field strength E and the distance R is given by $E = E_0 \times (R_0/R)$, where E_0 is the reference field strength and R_0 is the reference distance. This relationship allows relative measurements to be made as all constants are eliminated within the ratio and neither cable attenuation nor antenna mismatch or antenna dimensions are of importance.

If the logarithm of the foregoing equation is used, the deviation from the ideal curve may be easily seen because the ideal correlation of field strength and distance appears as a straight line. The deviations occurring in practice are then clearly visible. This indirect method shows quickly and easily any disturbances due to reflections and is far less difficult than the direct measurement of reflection attenuation.

With an anechoic chamber of the dimensions given above at low frequencies below 100 MHz there are no far field conditions, but the wall reflections are stronger, so that careful calibration is necessary. In the medium frequency range from 100 MHz to 1 GHz the dependence of the field strength to the distance meets the expectations very well. Above 1 GHz, because more reflections will occur, the dependence of the field strength to the distance will not correlate so closely.

B.1.2.4 Calibration and mode of use

The calibration and mode of use is the same as for an open air test site, the only difference being that the test antenna does not need to be raised and lowered whilst searching for a maximum, which simplifies the method of measurement.

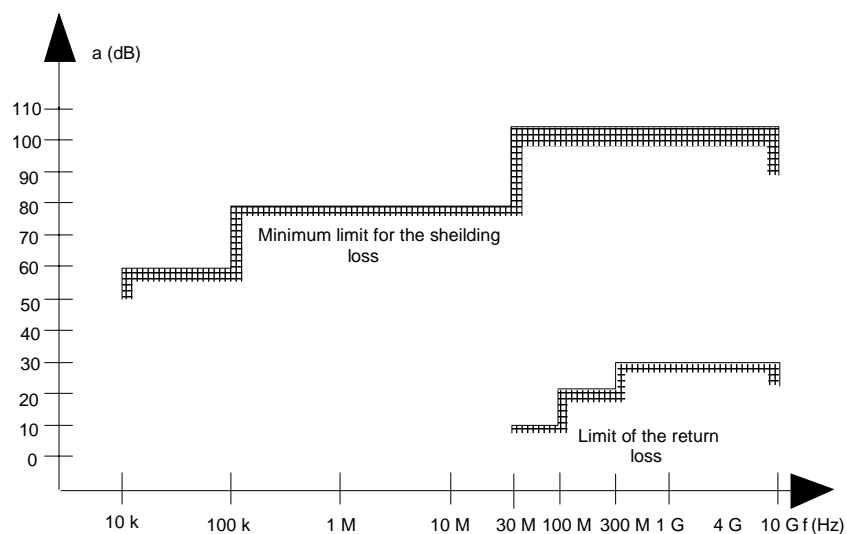

Figure B.2: Specification for shielding and reflections

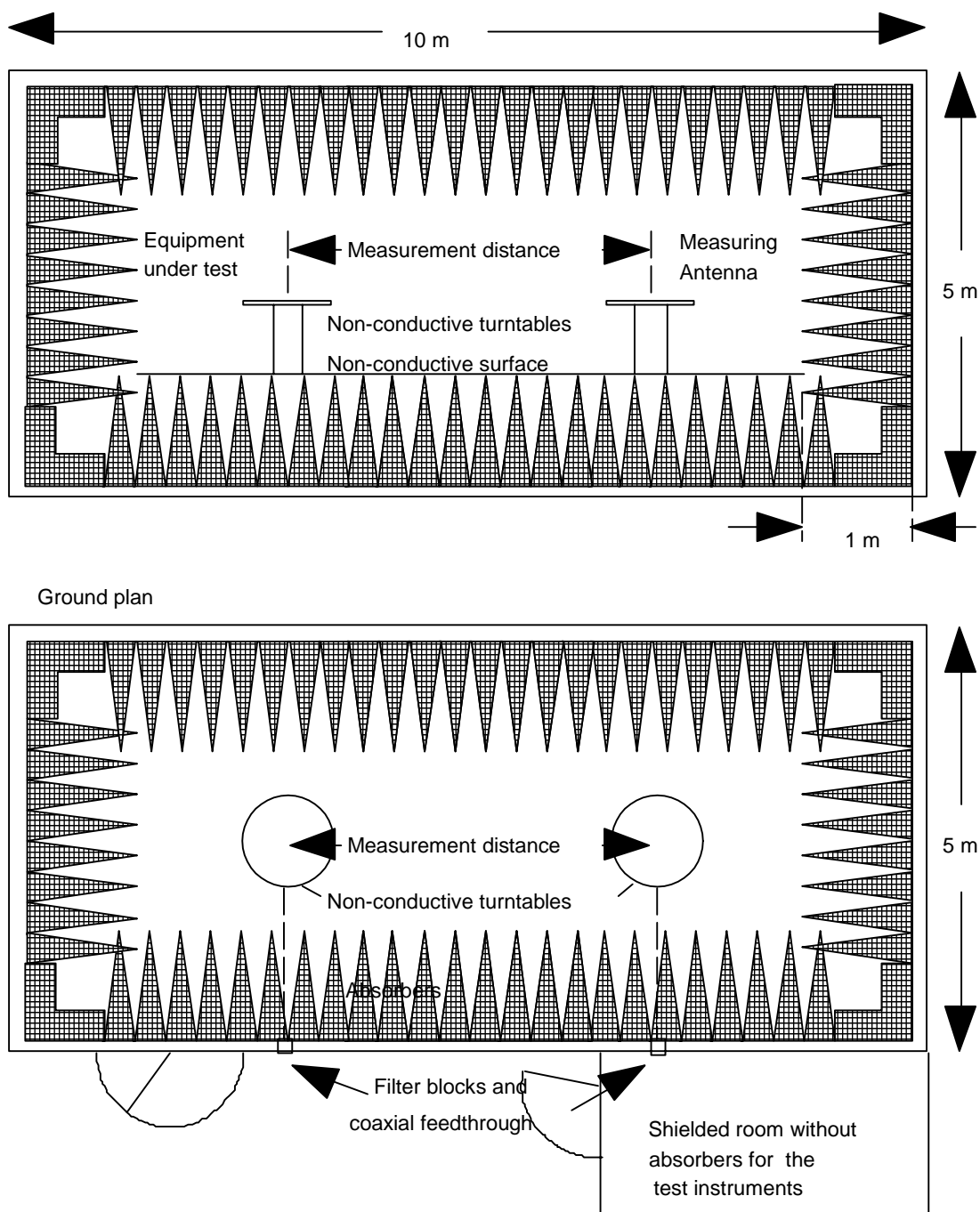

Figure B.3: Anechoic shielded chamber for simulated free space measurements

B.2 Test antenna

When the test site is used for radiation measurements the test antenna shall be used to detect the field from both the test sample and the substitution antenna. When the test site is used for the measurement of receiver characteristics the antenna shall be used as a transmitting antenna. This antenna shall be mounted on a support capable of allowing the antenna to be used in either horizontal or vertical polarization and for the height of its centre above the ground to be varied over the specified range. Preferably test antennas with pronounced directivity should be used. The size of the test antenna along the measurement axis shall not exceed 20 % of the measuring distance.

B.3 Substitution antenna

The substitution antenna shall be used to replace the UUT in substitution measurements. For measurements below 1 GHz the substitution antenna shall be a half wavelength dipole resonant at the frequency under consideration, or a shortened dipole, calibrated to the half wavelength dipole. For measurements between 1 GHz and 4 GHz either a half wavelength dipole or a horn radiator may be used. For measurements above 4 GHz a horn radiator shall be used. The centre of this antenna shall coincide with the reference point of the test sample it has replaced. This reference point shall be the volume centre of the sample when its antenna is mounted inside the cabinet, or the point where an outside antenna is connected to the cabinet.

The distance between the lower extremity of the dipole and the ground shall be at least 30 cm.

NOTE: The gain of a horn antenna is generally expressed relative to an isotropic radiator.

Annex C (normative): General description of measurement

This annex gives the general methods of measurements for RF signals using the test sites and arrangements described in annex B.

C.1 Conducted measurements

Conducted measurements may be applied to equipment provided with an antenna connector e.g. by means of a spectrum analyser.

C.2 Radiated measurements

Radiated measurements shall be performed with the aid of a test antenna and measurement instruments as described in annex B. The test antenna and measurement instrument shall be calibrated according to the procedure defined in this annex. The equipment to be measured and the test antenna shall be oriented to obtain the maximum emitted power level. This position shall be recorded in the measurement report. The frequency range shall be measured in this position.

Radiated measurements should be performed in an anechoic chamber. For other test sites corrections may be needed (see annex B). The following test procedure applies:

- a) A test site which fulfils the requirements of the specified frequency range of this measurement shall be used. The test antenna shall be oriented initially for vertical polarization unless otherwise stated and the transmitter under test shall be placed on the support in its standard position (clause B.1.1) and switched on.
- b) For average power measurements a non-selective voltmeter or wideband spectrum analyser shall be used. For other measurements a spectrum analyser or selective voltmeter shall be used and tuned to the measurement frequency.

In either case a) or b), the test antenna shall be raised or lowered, if necessary, through the specified height range until the maximum signal level is detected on the spectrum analyser or selective voltmeter.

The test antenna need not be raised or lowered if the measurement is carried out on a test site according to clause B.1.2.

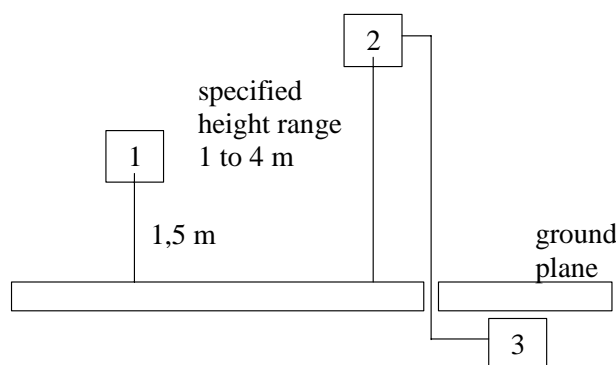

- 1: Equipment under test.
- 2: Test antenna.
- 3: Spectrum analyser or measuring receiver.

Figure C.1: Measurement arrangement 1

- The transmitter shall be rotated through 360° about a vertical axis until a higher maximum signal is received.

- The test antenna shall be raised or lowered again, if necessary, through the specified height range until a maximum is obtained. This level shall be recorded.

NOTE: This maximum may be a lower value than the value obtainable at heights outside the specified limits.

The test antenna need not be raised or lowered if the measurement is carried out on a test site according to clause B.1.2. This measurement shall be repeated for horizontal polarization. The result of the measurement is the higher power obtained from the two measurements with the indication of the corresponding polarization.

C.3 Substitution measurement

The actual signal generated by the measured equipment may be determined by means of a substitution measurement in which a known signal source replaces the device to be measured, see figure C.2. This method of measurement should be used in an anechoic chamber. For other test sites corrections may be needed, see annex B.

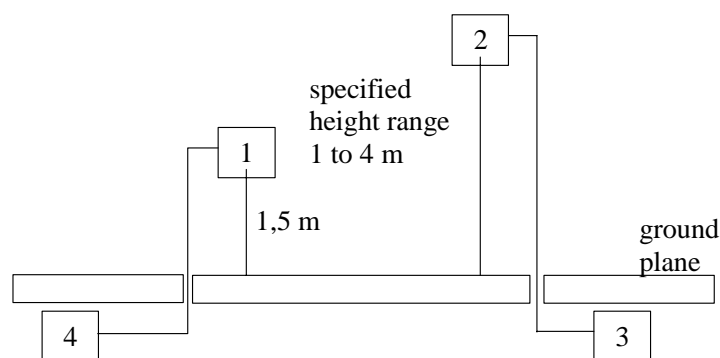

- 1: Substitution antenna.
- 2: Test antenna.
- 3: Spectrum analyser or selective voltmeter.
- 4: Signal generator.

Figure C.2: Measurement arrangement 2

Using measurement arrangement 2, figure C.2, the substitution antenna shall replace the transmitter antenna in the same position and in vertical polarization. The frequency of the signal generator shall be adjusted to the measurement frequency. The test antenna shall be raised or lowered, if necessary, to ensure that the maximum signal is still received. The input signal to the substitution antenna shall be adjusted in level until an equal or a known related level to that detected from the transmitter is obtained in the test receiver.

The test antenna need not be raised or lowered if the measurement is carried out on a test site according to clause B.1.2.

The radiated power is equal to the power supplied by the signal generator, increased by the known relationship if necessary and after corrections due to the gain of the substitution antenna and the cable loss between the signal generator and the substitution antenna.

This measurement shall be repeated with horizontal polarization. The result of the measurement is the higher power obtained from the two measurements with the indication of the corresponding polarization.

Annex D (normative): DFS parameters

Table D.1: DFS requirement values

Parameter	Value
Channel Availability Check Time	60 s
Channel Move Time	10 s
Channel Closing Transmission Time	260 ms
Non-Occupancy Period	30 min

Table D.2: Interference threshold values, master

Maximum transmit power (eirp)	Value (see note)
≥ 200 mW	-64 dBm
< 200 mW	-62 dBm
NOTE: This is the level at the input of the receiver assuming a 0 dBi receive antenna.	

Table D.3: Interference threshold values, slave

Maximum transmit power (eirp)	Value (see note)
≥ 200 mW	-64 dBm
< 200 mW	N/A
NOTE: This is the level at the input of the receiver assuming a 0 dBi receive antenna.	

Table D.4: Parameters of DFS test signals

Radar test signal	Pulse width W [μ s] (see note 5)	Pulse repetition frequency PRF [pps]	Pulses per burst (see note 1)	Detection probability with 30 % channel load
1 - Fixed	1	750	15	$P_d > 60\%$
2 - Variable	1, 2, 5	200, 300, 500, 800, 1 000	10	$P_d > 60\%$
3 - Variable	10, 15	200, 300, 500, 800, 1 000	15	$P_d > 60\%$
4 - Variable	1, 2, 5, 10, 15	1 200, 1 500, 1 600	15	$P_d > 60\%$
5 - Variable	1, 2, 5, 10, 15	2 300, 3 000, 3 500, 4 000	25	$P_d > 60\%$
6 - Variable modulated (see note 6)	20, 30	2 000, 3 000, 4 000	20	$P_d > 60\%$

NOTE 1: This represents the number of pulses seen at the RLAN per radar scan:

$$N = \{[\text{antenna beamwidth (deg)}] \times \{\text{pulse repetition rate (pps)}\}\} / \{[\text{scan rate (deg/s)}]\}.$$

NOTE 2: The test signals above only contain a single burst of pulses.

NOTE 3: The number of pulses per burst given in this table simulates real radar systems and takes into account the effects of pulse repetition rate and pulse width on the detection probability for a single burst.

NOTE 4: P_d gives the probability of detection per simulated radar burst and represents a minimum level of detection performance under defined conditions - in this case a 30 % traffic load.

Therefore P_d does not represent the overall detection probability for any particular radar under real life conditions. In general 5 sequential bursts are needed to achieve a real life detection rate of better than 99 % for any radar that falls within the scope of this table.

NOTE 5: The pulse width used in these tests is assumed to be representative of real radar systems with different pulse widths and different modulations. The pulse width is assumed to have an accuracy of $\pm 5\%$.

NOTE 6: The modulation to be used for the radar test signal 6 is a chirp modulation with a $\pm 2,5$ MHz frequency deviation which is described below.

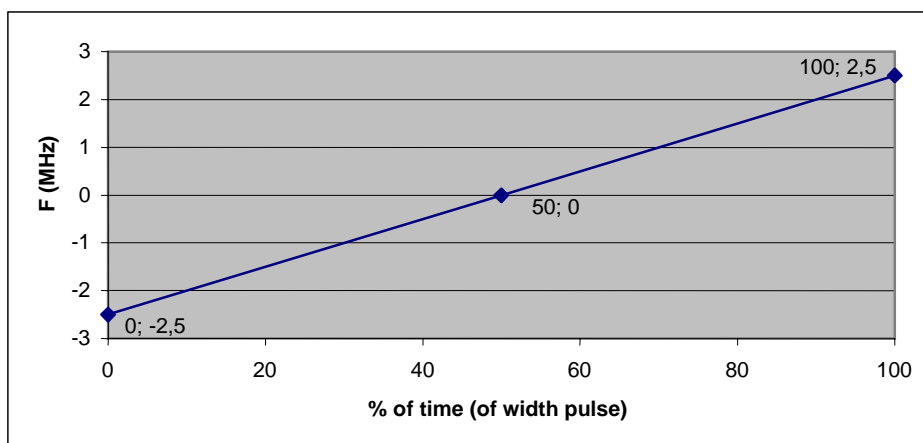

Figure D.1: General structure of a single burst DFS test transmission

Annex E (informative): The EN title in the official languages

Language	EN title
Czech	Širokopásmové rádiové přístupové sítě (BRAN); Vysokovýkonná RLAN 5 GHz; Harmonizovaná EN pokrývající základní požadavky článku 3.2 Směrnice R&TTE
Danish	Bredbåndsradioksesnet (BRAN); 5GHz high-performance RLAN; Harmoniseret EN omfatter essentielle krav fra artikel 3.2 af R&TTE direktiv
Dutch	Breedband netwerken met radio toegang (BRAN). 5 GHz high performance RLAN apparatuur. Geharmoniseerde EN betreffende de wezenlijke vereisten, als aangegeven in artikel 3, lid 2, van de R&TTE Richtlijn
English	Broadband Radio Access Networks (BRAN); 5 GHz high performance RLAN; Harmonized EN covering essential requirements of article 3.2 of the R&TTE Directive
Estonian	Lairiba raadiojuurdepääsuvõrgud (BRAN); Raadiosagedusalas 5 GHz töötavate suure edastuskiirusega RLAN seadmete põhinõuded, harmoneeritud EN R&TTE direktiivi artikli 3.2 alusel
Finnish	Laajakaistaiset radioliityntäverkot (BRAN); 5 GHz korkean suorituskyvyn RLAN; Yhdenmukaistettu standardi (EN), joka kattaa R&TTE-direktiivin artiklan 3.2 mukaiset olennaiset vaatimukset
French	Réseaux radio fréquence large bande (BRAN); Réseaux locaux radio haute performance 5 GHz ; EN harmonisé couvrant les exigences essentielles de l'article 3.2 de la directive R&TTE
German	Breitbandige Funkzugangsnetze (BRAN); Lokale Funknetze mit hoher Leistung im 5GHz Band; Harmonisierte Europäische Norm (EN) für die grundlegenden Anforderungen des Artikels 3.2 der Funk- und Telekommunikationsendgeräterichtlinie (R&TTE Richtlinie)
Greek	Ευρυζωνικά Δίκτυα Ραδιοεπικοινωνίας (BRAN); Υψηλής απόδοσης RLAN στους 5 GHz; Εναρμονισμένη EN που καλύπτει τις βασικές προϋποθέσεις του άρθρου 3.2 της οδηγίας R&TTE
Hungarian	Széles sávú, rádiós hozzáférési hálózatok (BRAN). 5 GHz-es, különleges minőségű RLAN. Az R&TTE-irányelv 3.2. cikkelyének lényegi követelményeit tartalmazó harmonizált európai szabvány
Icelandic	Þráðlaus breiðbandsaðgangsnæt (BRAN); 5 GHz hágæða RLAN; Samræmdur Evrópustaðall um grunnkröfur 2. mgr. 3. gr. í tilskipun 1999/5/EC um fjarskiptabúnað og endabúnað til fjarskipta
Italian	Reti di accesso radio a larga banda (BRAN); 5GHz RLAN ad alte prestazioni; EN armonizzati soddisfacenti i requisiti dell'articolo 3.2 della Direttiva R&TTE
Latvian	Platjoslas radiopiekļuves tīkli (BRAN) - 5 GHz augstas veiktspējas vietējais radiopiekļuves tīkls (RLAN) - Harmonizēts Eiropas standarts (EN), kas atbilst R&TTE direktīvas 3.2.punkta būtiskajām prasībām
Lithuanian	Plačiajuostės radijo ryšio priegios tinklai. 5 GHz dažnio aukštos kokybės vietinis radijo ryšio tinklas. Darnusis Europos standartas, apimantis esminius 1999/5/EC direktyvos 3.2 straipsnio reikalavimus
Maltese	Netwerks għal Access għal Frekwenza Wiesgħa Radjofonika (BRAN); 5 GHz kapacità għolja RLAN; EN armonizzat li jkopri rekwiżiti essenzjali ta" artiklu 3.2 tad-Direttiva R&TTE
Norwegian	Bredbåndsradioksesnett (BRAN); 5 GHz høyytelses RLAN; Harmonisert EN som dekker de grunnleggende krav i R&TTE-direktivets artikkel 3.2
Polish	Sieci szerokopasmowego dostępu radiowego (BRAN) - Sieci RLAN wysokiej jakości, zakresu 5 GHz - Zharmonizowana EN zapewniająca spełnienie zasadniczych wymagań artykułu 3.2 dyrektywy R&TTE
Portuguese	Redes de Acesso Rádio em Banda Larga (BRAN); RLAN de alto desempenho na faixa dos 5 GHz; EN harmonizada cobrindo os requisitos essenciais no âmbito do Artigo 3.2 da Directiva R&TTE
Slovak	Širokopásmové rádiové prístupové siete (BRAN). Vysokovýkonná RLAN v pásme 5 GHz. Harmonizovaná EN vzťahujúca sa na základné požiadavky podľa článku 3.2 smernice R&TTE
Slovenian	Širokopasovna radijska dostopovna omrežja (BRAN) - Zelo zmogljivo radijsko lokalno omrežje (RLAN) na 5 GHz - Harmonizirani EN, ki zajema bistvene zahteve člena 3.2 direktive R&TTE
Spanish	Redes de acceso por radio de banda ancha (BRAN); RLAN de alto rendimiento en la banda de 5 GHz; Estandart ETSI cubriendo los aspectos esenciales del artículo 3.2 de la Directiva R&TTE
Swedish	Bredbandsradio-accessnät (BRAN); 5 GHz hög kapacitet RLAN; Harmoniserad EN omfattande väsentliga krav enligt artikel 3.2 i R&TTE-direktivet

Annex F (informative): Bibliography

ITU-R Recommendation M.1652: "Dynamic frequency selection (DFS) in wireless access systems including radio local area networks for the purpose of protecting the radiodetermination service in the 5 GHz band".

History

Document history		
V1.2.3	August 2003	Publication
V1.3.1	March 2005	One-step Approval Procedure OAP 20050729: 2005-03-30 to 2005-07-29
V1.3.1	August 2005	Publication